

DPM® LANDMARK STRUCTURES® HO SCALE BUILDING KIT



TERA SURPLUS WINDOW WAREHOUSE #35500

INSTRUCTIONS

Refer to the HO scale Modular Building System™ General Instructions before cutting or assembling parts.

Match corresponding letters to determine where assemblies join. **Example:** Edge “I” – View #2 and Edge “I” – View #3 join each other as an “outside” corner. Edge “M” – View #2 and Edge “M” – View #3 join as an “inside” corner.

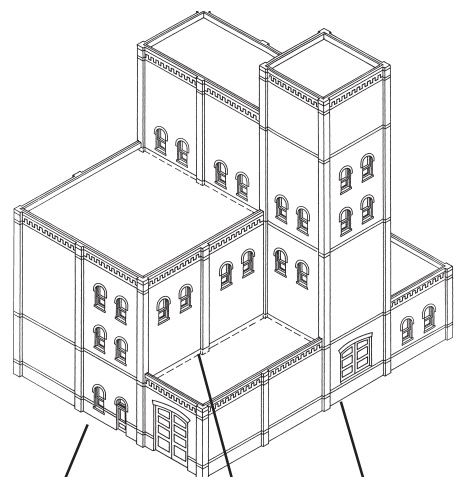

VIEW #4
VIEW #1
Cut notches in Roof

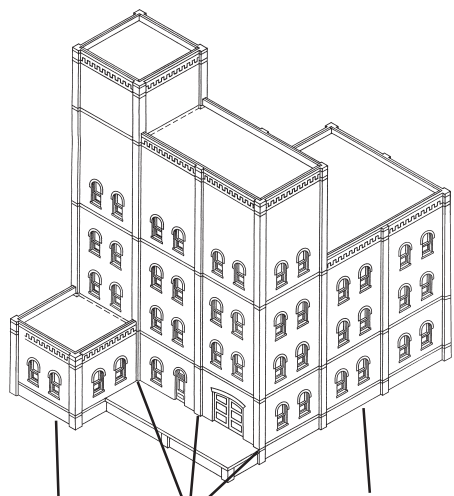

VIEW #2
VIEW #3
Cut notches in Roof

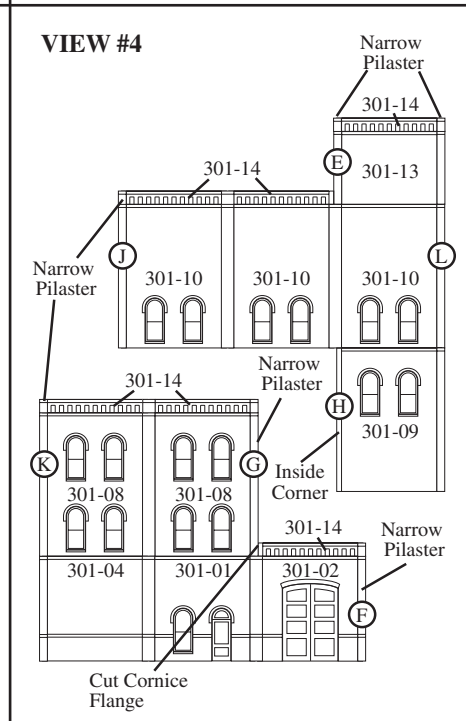
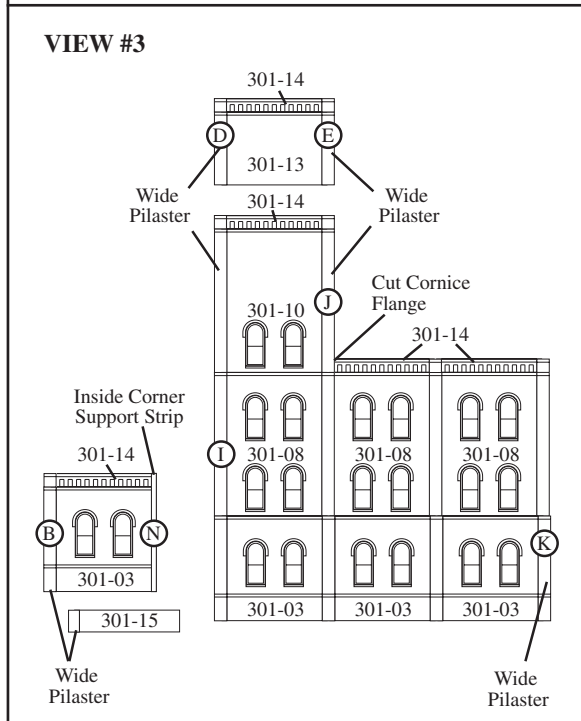
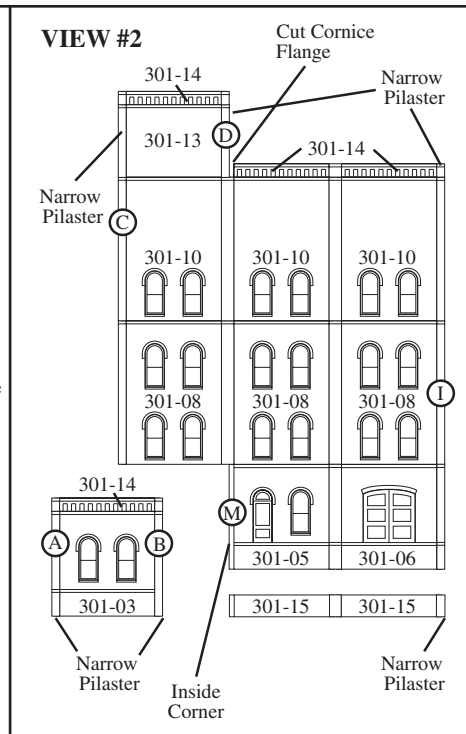
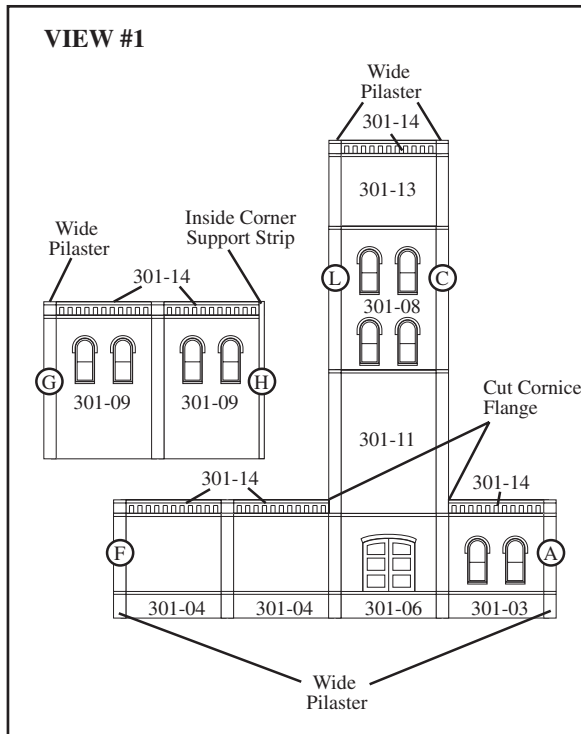

Create interest on your layout. Add lights to your buildings quickly and easily using the Woodland Scenics® Just Plug® Lighting System. Bereichern Sie Ihre Anlage: Mit dem Woodland Scenics Just Plug Beleuchtungssystem lassen sich Gebäude schnell und einfach beleben.

CAUTION: Cutting tool recommended. Use with care. / **MISE EN GARDE:** Outil de coupe recommandé. Utilisation avec soin. / **PRECAUCIÓN:** Herramienta cortante recomendada. Uso con cuidado. / **VORSICHT:** Schneidwerkzeug empfohlen. Gebrauch sorgfältig.

Model making product. Not a toy! Not suitable for children under 14 years! / **Produit pour le modélisme. Pas un jouet! Pas adapté aux enfants de moins de 14 ans! / Producto para modelismo. No es un juguete! No adecuado para niños menores de 14 años! / Modellbauartikel. Kein Spielzeug! Nicht geeignet für Kinder unter 14!**



**HO SCALE MODULAR BUILDING SYSTEM
STYRENE PLASTIC**



Model making product. Not a toy! Not suitable for children under 14 years! / Produit pour le modélisme. Pas un jouet! Pas adapté aux enfants de moins de 14 ans! / Producto para modelismo. No es un juguete! No adecuado para niños menores de 14 años! / Modellbauartikel. Kein Spielzeug! Nicht geeignet für Kinder unter 14!

CAUTION: Cutting tool recommended. Use with care.
MISE EN GARDE : Outil de coupe recommandé. Utilisation avec soin.
PRECAUCIÓN: Herramienta cortante recomendada. Uso con cuidado.
VORSICHT: Schneidwerkzeug empfohlen. Gebrauch sorgfältig.

**WALL SECTIONS MAKE WALL PANELS
WALL PANELS MAKE BUILDINGS**

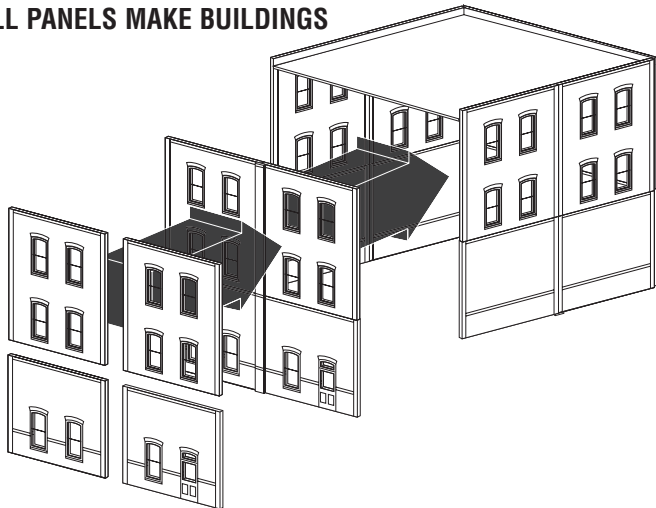

WOODLAND SCENICS®
Manufactured by **WOODLAND®**
PO BOX 98, LINN CREEK, MO 65052 • woodlandscenics.com
Distributed by Bachmann Europe, 13 Moat Way, Barwell, Leicestershire, LE9 8EY.
ENGLAND. Am Umspannwerk 5, 90518 Altdorf b. Nürnberg. GERMANY.

ONE-STORY WALL SECTIONS
2 11/16" w x 1 7/8" h (4 per pkg)

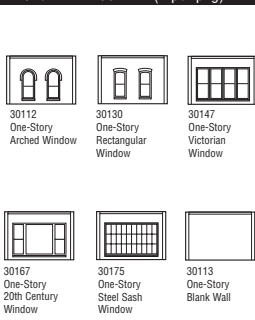

TWO-STORY WALL SECTIONS
2 11/16" w x 3 11/16" h (4 per pkg)

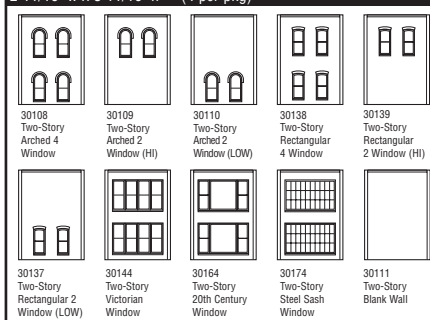

STREET LEVEL WALL SECTIONS
2 11/16" w x 2 11/16" h (4 per pkg)

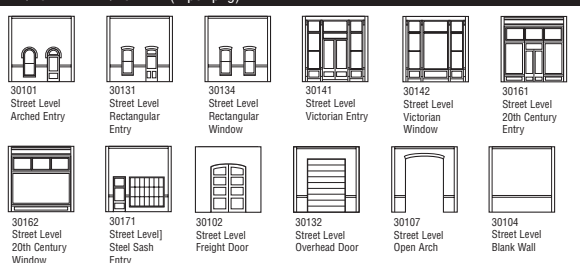

CORNICE
2 11/16" w x 3/8" h (8 per pkg)

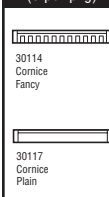

DOCK LEVEL WALL SECTIONS
2 11/16" w x 2 11/16" h (4 per pkg)

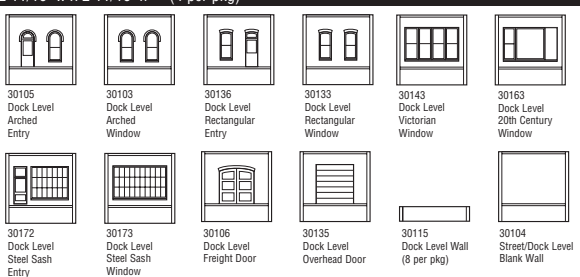

POWERHOUSE WINDOW
2 11/16" w x 7 3/8" h (2 sets per pkg)

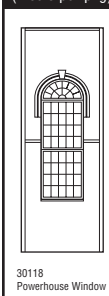

GENERAL INSTRUCTIONS HO SCALE MODULAR BUILDING SYSTEM™

Using the Modular Building System

More than 40 Interchangeable Plastic Wall Sections make Walls.
Walls make Buildings any size or shape.

The HO Scale Modular Building System is available as individual pieces or complete kits.

Individual Wall Sections and Accessories: Wall Section packages contain four identical Wall Sections and connection Pilasters - plus Doors, Windows and Clear Window Material when needed. Wall Section Packages include Street Level, One-Story, Two-Story and Dock Level. Cornice and Dock Riser packages contain eight identical Sections. The Roof & Trim Kit (30190) contains materials to make and accessorize a roof. The Learning Kit (36000) teaches Modular techniques while you build a complete, small building. Create your own design using the Modular Planning Packet (30191). It contains full-sized drawings of all Modular Wall Sections so you can design your own three-dimensional mock-up buildings.

Designer Bulk Packs: Each Designer Bulk Pack features a different architectural style with plans to build three specific structures. Everything is included to build one of the three options. Bulk Packs are an economical way to purchase Modular parts for your own designs.

Modular Building Kits: These industrial building kits contain a variety of Wall Sections and complete building instructions - plus Roof and Clear Window Material. They are easy to assemble and can be expanded using additional DPM Modular parts.

BASIC MODULAR BUILDING INFORMATION

NOTE: If you are building a Designer Bulk Pack structure, refer to drawings in each kit for placement of individual Wall Sections as you follow these instructions.

Connect Wall Sections (Fig. 1) with Pilasters to form wall panels (Fig. 2). Typically, the same type of Wall Section is used to create wall panels (connect Street Level Wall Sections to Street Level Wall Sections, One-Story Wall Sections to One-Story Wall Sections and so on). Wall panels are attached on top of each other to make entire walls. Connect entire walls to create a building.

Pieces come attached to a sprue (a piece of resin left over from molding process). Keep parts attached to sprues until you are ready to use them (Fig. 3). Remove the part from the sprue by scoring the connection point with a hobby knife, then snap part off. Or, simply remove with cutting shears. Join parts with plastic cement or CA glue. Plastic cement works by dissolving the surface of plastic and welding parts together, so avoid contact with detail on parts and Clear Window Material. Always allow glue to set before proceeding to the next step. A squaring block assures right angles when sanding or forming corners. Use a 2" x 2" x 10" block (Figs. 12, 14 and 15).

Fig. 1 WALL SECTION

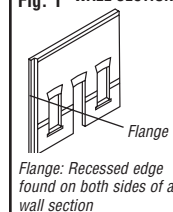

Fig. 2

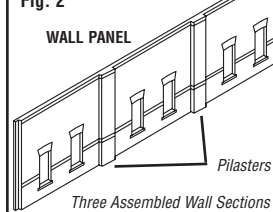
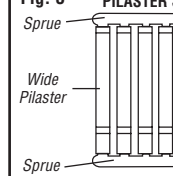
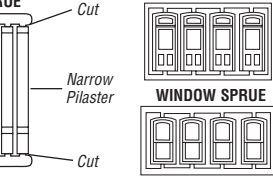

Fig. 3 PILASTER SPRUE



DOOR SPRUE



WINDOW SPRUE



MODULAR BUILDING INSTRUCTIONS

Read through the instructions before beginning. Understanding the system makes it fun and the parts easy to put together.

Prepare Wall Sections

Remove excess plastic (flash) from Wall Sections and Pilasters with a hobby knife and sandpaper as instructed in Fig. 4. Wash all parts in warm, soapy water, then rinse and let dry.

Fig. 4 - Prepare Parts

Remove flash from edges of Wall Sections and Pilasters, but do NOT sand parts level until Wall Assembly.

Remove Flash and Excess Plastic:

- **-tabs:** Score with hobby knife and snap off or cut with flush cutting shears. Sand flush.
- **Nubs on Flange:** Sand smooth so Pilasters lie flush.
- **Flash:** Place hobby knife blade on part at slight angle. Scrape in opposite direction so blade does not cut into part. Sand smooth.

Do not cut into detail or alter edges of parts. Angle the blade and scrape.

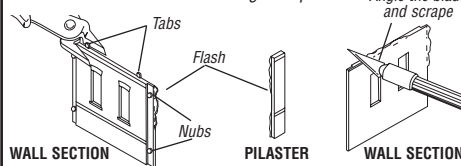

Create Wall Panels

1. Create Street Level Wall Panels first and work up from there.
2. Attach Wall Sections together horizontally with a Wide Pilaster glued in flanges on adjacent Wall Sections. Keep Wall Sections and Pilasters level by using a 1/8" thick straightedge as a guide along top edges (Fig. 5). Apply glue along outer edge of flanges to keep glue off brick detail (Fig. 5 inset). Fit Pilasters snugly between Wall Sections (Fig. 6). Continue joining Wall Sections to create desired length of Wall Panel. Do not glue Pilasters to ends of Wall Panels where corners will be formed. As you create Wall Panels, be sure Pilasters line up on adjacent Wall Panels (Fig. 13). Do not glue Wall Panels together until Wall Assembly.

Fig. 5

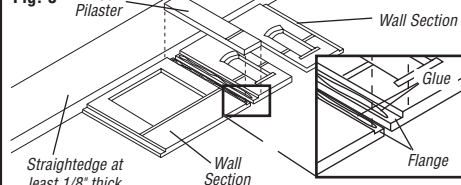
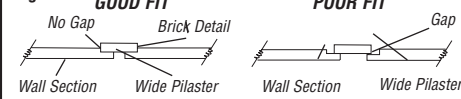

Fig. 6



3. Cornices are horizontal trim sections that sit along tops of buildings. These are assembled using short Cornice Pilasters. Construct Cornice Wall Panels in same manner as regular Wall Panels. Check alignment of Cornice Pilasters with the Pilasters of the Wall Panel that sits below (Fig. 13).

4. Corners are formed during Building Assembly, but you need to prepare for corners now. Note the difference between outside corners and inside corners (Fig. 7).

Outside Corners: At this time, attach Wide Pilasters to edges of front and back wall panels. Attach Narrow Pilasters to edges of left and right side wall panels. Outside Corners are formed by connecting Wide and Narrow Pilasters (Fig. 8). Narrow Pilasters are brick-detailed on one edge and smooth on the other. Attach smooth edge of Narrow Pilaster to back of Wide Pilaster (Fig. 9).

Inside Corners: Do NOT attach Pilasters to ends of wall panels that will be part of an inside corner. Use Inside Corner Strips (sold separately, included with Designer Bulk Packs and Roof & Trim Kit #30190) or .080" x .080" styrene plastic strips. An Inside Corner Strip is attached to only one Wall Panel edge (Fig. 7 inset). Cut Corner Strip to fit height of Wall Panel, extending it slightly beyond the top and bottom (Fig. 10). This excess will be sanded off later. Glue Corner Strip along Wall Panel flange where inside corner will be formed. Make sure it is seated square and flush. Let glue dry completely, then sand to remove excess plastic (Fig. 7). Repeat these steps for multiple story Wall Panels that are part of the same Wall.

Wall Assembly

1. Tack 120-grit sandpaper to flat surface. Make sanding area longer than longest Wall Panel.
2. Sand Wall Panel edges to even out height variations and remove beveled edges. Keep edges flat on sandpaper and do not sand into brick detail (Fig. 12).
3. To form entire Walls, glue Wall Panels together vertically, keeping Pilasters aligned. Take care to keep glue off detail. Glue Cornice Wall Panels to Walls at top level and let dry.
4. On side Walls, sand edges (without brick detail) of Narrow Pilasters to remove bevels.
5. Where Inside Corner Strips are attached, sand edge of Wall Panel to an angle so it won't touch adjacent Wall at corner (Fig. 11).

NOTE: During the assembly process, test fit Wall Panels to ensure everything stays aligned horizontally and vertically during Building Assembly. Make adjustments as needed.

Building Assembly

1. Glue Walls together at corners to form three-dimensional building. Use a squaring block to make sure corners are square (Fig. 15). Let dry.
2. A parapet is the part of a building wall that extends above the roof. Prior to installing Parapet Wall Trim, place building upside down on cardboard or styrene Roof Material and trace roof opening(s) along inside of walls. If roof opening can't be traced, measure opening and transfer measurements to cardboard or Roof Sheet. Set tracings aside until Roof section.

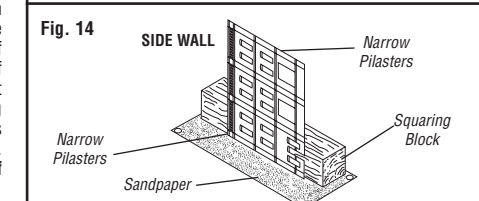
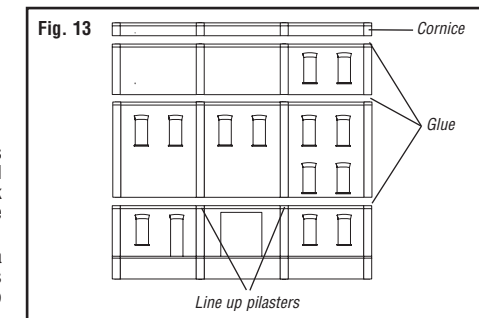
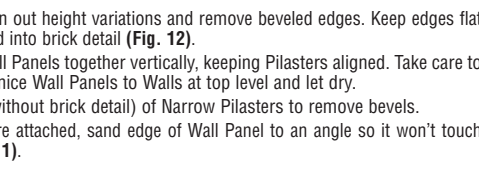
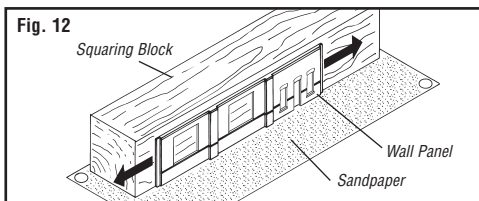
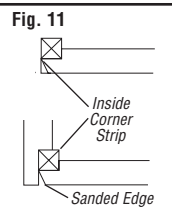
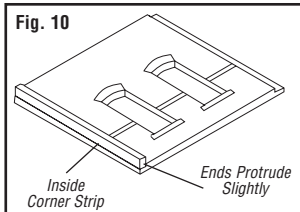
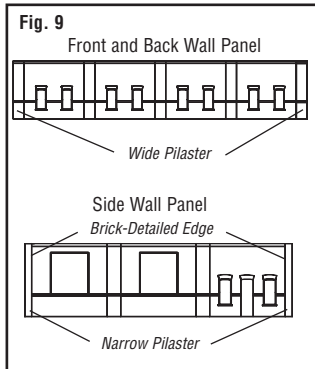
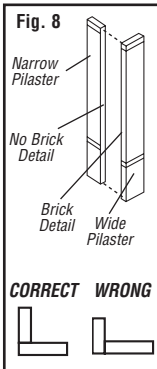
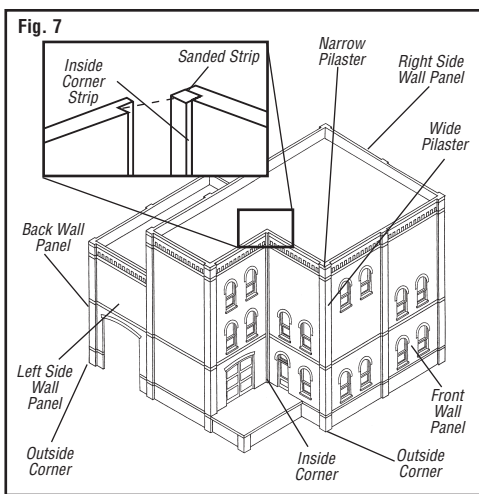

3. Cut Parapet Wall Trim (sold separately, included with Roof & Trim Kit) to fit around inside top edge of building (Fig. 16). Lightly sand the cut ends without rounding, then glue in place. Keep Trim flush with top edge and fill voids at top of wall sections with spackle or plastic putty (Fig. 16 and inset).

Loading Dock Assembly

1. If your building has a loading dock, construct dock wall panels in same manner as wall panels (refer to Create Wall Panels). Use Wide Dock Pilasters to join Dock Riser Wall Sections. Only front and side dock wall panels are needed (Fig. 17).
2. Glue Wide Pilasters to both ends of front dock panel. Glue brick-detailed edge of a Narrow Pilaster to side dock panel. The smooth edge of Narrow Pilaster will join front wall panel at corner.
3. Cut off flanges where side wall panels will meet the building. For a narrow dock, cut more off side wall panels, making sure they are cut to equal lengths (Fig. 17).
4. Glue Pilasters on ends of side dock panels to front dock panel. Glue assembled dock to building.
5. For decking, use .080" styrene sheet (sold separately, included with Modular Building Kits). Deck should overlap Dock Walls slightly, covering tops of Dock Pilasters. Draw deck measurements on styrene, including where to cut or file notches to clear building Pilasters (Fig. 18). Cut and fit. Use matte-finish hobby paint such as a concrete color for the deck. Attach deck to top of Dock Riser Walls after painting building.

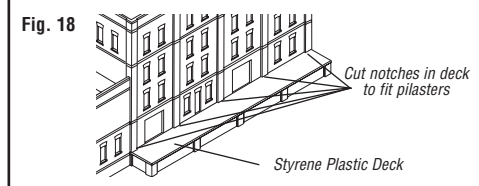
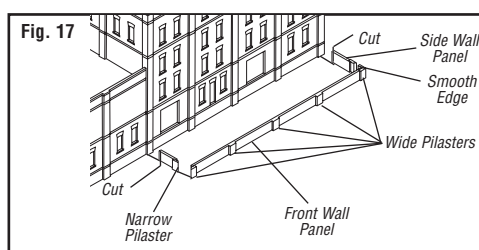
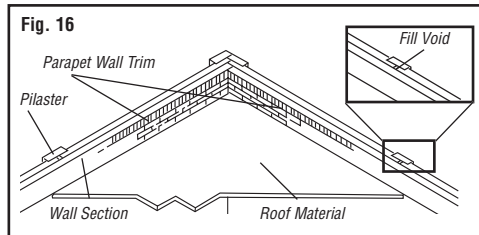
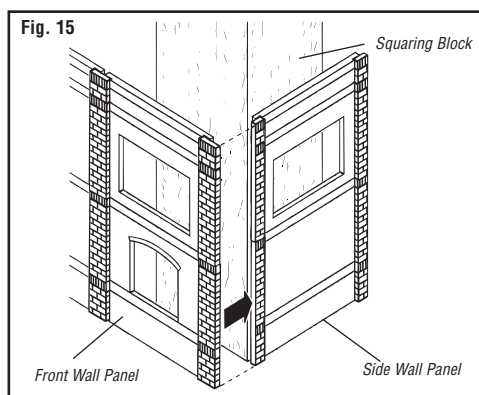

Painting

For airbrushing, we recommend matte finish enamel hobby paint. For brushing, use an acrylic matte finish paint. Aerosol spray paints in matte finish may also be used. Colors are your choice. We prefer natural brick colors for the building, Cornices, Parapet and Loading Dock Walls. Windows and doors can be the same or a complimentary color.

1. Paint the building (Walls, Cornices, Parapet Walls, Dock Riser Walls).
2. Paint window frames and doors while on sprues.
3. Weathering: Use thinned matte black paint (such as grimy black) airbrushed as a light mist over entire building, windows and doors. Add more where discoloration occurs (under windows, along tops of walls).
4. Scrape paint from any surface yet to be glued.
5. Add Dry Transfer Decals for signs on building sides.

Windows and Doors

1. After paint has dried, remove window frames and doors from sprues.
2. If window signs are desired, apply decals to Clear Window Material before attaching to Window Frames.
3. Glue Window Material to Window Frames and Doors.
4. Attach Windows and Doors from inside building.

Roof

The Roof & Trim Kit includes Roof Material (styrene plastic sheet), plus assorted Roof Vents and Hatches suitable for all buildings. These items are also included with Designer Bulk Packs.

1. If cardboard roof patterns were made (refer to Building Assembly, Step 2), cut out and test fit under Parapet Wall Trim. Adjust size, then trace onto Roof Material.
2. Cut out Roof, test fit and adjust if needed. Do not glue at this time.
3. For a larger roof, join two pieces of Roof Material. Cut scrap styrene about 1/4" wide and the length of the roof. Glue to underside of Roof Sections to provide support.
4. Paint Roof matte black.
5. Glue Roof to bottom of Parapet Wall Trim from underneath the building (Fig. 16).
6. To finish the roof area, paint Roof Details (sold separately, included in Designer Bulk Packs or Roof & Trim Kit), let dry and glue in place.

NOTE: If you have designed a building with exceptionally tall walls, you may need to install internal bracing so walls don't bow. Insert and glue styrene plastic bracing as required.

Create interest on your layout. Add lights to your buildings quickly and easily using the Woodland Scenics® Just Plug® Lighting System.

We make every effort to ensure our kits are manufactured complete. However, if this kit is missing a part, please make note of the kit name, number and missing part. Contact the Woodland Sales and Customer Service Department at PO Box 98, Linn Creek, MO 65052, 573-346-5555 or sales@woodlandscenics.com.

DPM[®] LANDMARK STRUCTURES[®] HO SCALE MODULAR WALL SYSTEM

PLANNING PACKET 30191



Refer to enclosed instruction sheet to familiarize yourself with the system. All wall sections are reproduced full size on both sides of this sheet. Make multiple copies on a photocopy machine, cut out wall sections and glue onto cardstock. When cutting out wall sections, leave a "glue tab" above each piece to glue to an upper story or cornice. The gray edges on the wall sections represent where you should attach pilasters. The true edges of the wall section are indicated by the dotted lines in the gray areas. Align pilasters vertically to make a single pilaster between walls. When aligning pilasters, overlap the pilaster of one wall section over the pilaster of another wall section. An entire structure can be built in this manner. You will know in advance exactly how it will look on your layout and which part to purchase.

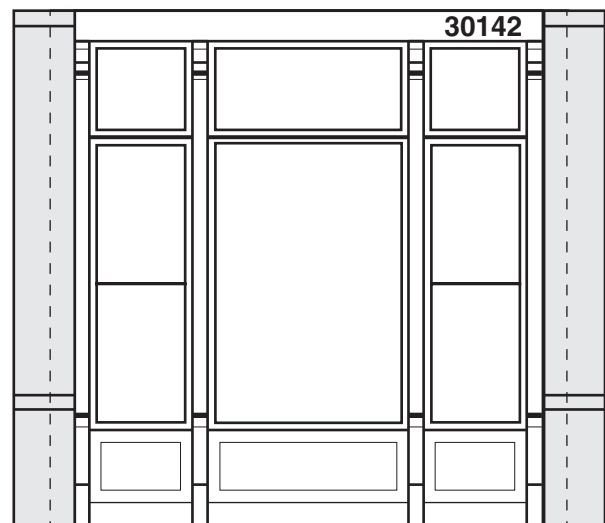
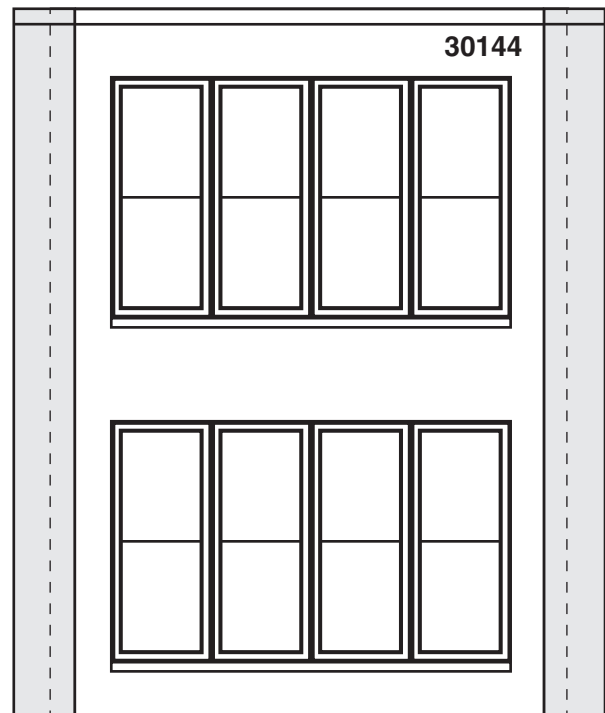
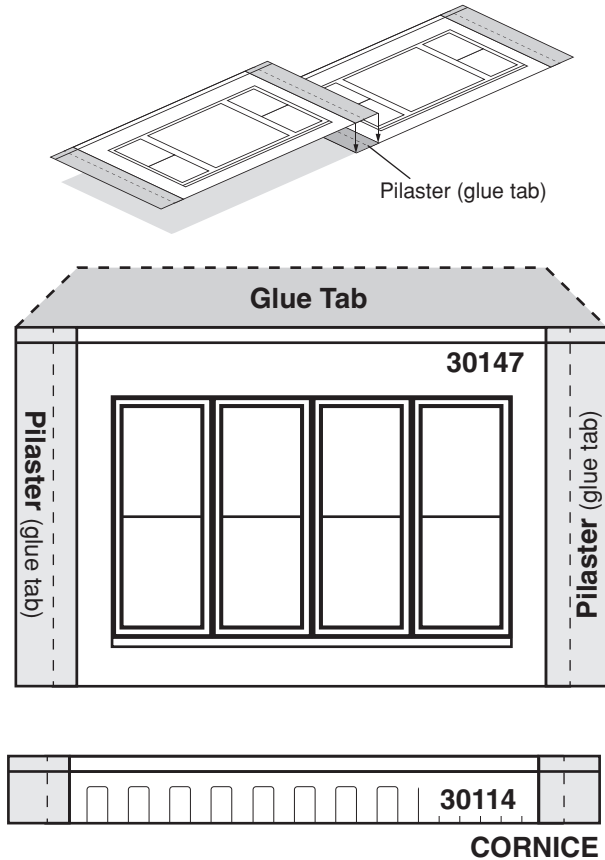

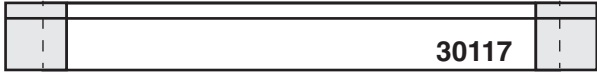

DOCK RISER

