

THE SCENERY KIT

S927 INSTRUCTION BOOKLET



We feel confident you will be happy with the display piece that you are about to build. This kit includes the base and materials needed to construct a 10" x 18" diorama on which you can display an engine, piece of rolling stock or military model. We will teach you how to use our terrain and landscape systems.

Model making product. Not a toy! Not suitable for children under 14 years! / Produit pour le modélisme. Pas un jouet! Pas adapté aux enfants de moins de 14 ans! / Producto para modelismo. No es un juguete! No adecuado para niños menores de 14 años! / Modellbauartikel. Kein Spielzeug! Nicht geeignet für Kinder unter 14!



ALLERGY CAUTION: Contains tree nut by-products.
ALLERGIQUE ATTENTION : Contient l'écrou arborescence sous-produits.
PRECAUCION ALERGIAS: Contiene derivados de frutos secos.
ALLERGIEWARNUNG: Beinhaltet Baumnuss – Nebenprodukte.



CAUTION: Contains Hydrocal that may be harmful if misused. Read package information. We do not recommend using Lightweight Hydrocal for body casts as it may irritate skin and develop heat sufficient enough to cause burns. Do not take internally. Do not pour excess plaster down drain. Discard in trash.



MODELING AND CARE INFORMATION

This kit suggests the use of products which may stain or cause damage. Take care to cover project area and clothing appropriately. Follow recommendations for use and clean up.

THE SCENERY KIT (S927)

KIT CONTENTS

| <u>DESCRIPTION</u> | <u>QUANTITY</u> |
|--|---|
| Precut Hardboard: Side Frames - 1/8 in (3.17 mm) | 4 |
| Precut Hardboard: Sub-Roadbed - 1/4 in (6.35 mm) | 1 |
| Corner Blocks | 5 |
| HO Track-Bed™ Strip - 18 in (45.7 cm) | 1 |
| HO Track Strip - 18 in (45.7 cm) | 1 |
| Foam Applicator..... | 1 |
| Stir Sticks | 2 |
| Scenic Cement™ | 8 fl oz (236 mL) |
| Spray Head for Scenic Cement..... | 1 |
| Hob-e-Tac® Adhesive..... | 1 fl oz (29.5 mL) |
| Lightweight Hydrocal®* Plaster | 4.8 oz (136 g) |
| Plaster Cloth Roll..... | 8 in x 7.5 ft, 5 ft (20.3 cm x 228 cm, 46.4 dm ²) |
| Culvert – Concrete | 1 |
| Rock Castings | 4 |
| Earth Colors™ Liquid Pigments (3-color strip) | |
| Rock Colors (Yellow Ocher, Burnt Umber, Black) | 0.13 fl oz (3.84 mL) ea |
| Earth Undercoat | 0.67 fl oz (19.8 mL) |
| Burnt Grass Fine Turf | 3.6 in ³ (58.9 cm ³) |
| Earth Fine Turf..... | 3.6 in ³ (58.9 cm ³) |
| Soil Fine Turf..... | 3.6 in ³ (58.9 cm ³) |
| Yellow Grass Fine Turf..... | 3.6 in ³ (58.9 cm ³) |
| Medium Green Coarse Turf | 3.6 in ³ (58.9 cm ³) |
| Green Blend Blended Turf | 10.8 in ³ (176 cm ³) |
| Medium Green Clump-Foliage™..... | 16.2 in ³ (265 cm ³) |
| Dark Green Clump-Foliage..... | 16.2 in ³ (265 cm ³) |
| Green Poly Fiber..... | 1 g (0.035 oz) |
| Light Green Field Grass | 3 g (0.1 oz) |
| Tree Armatures..... | 3 |
| Brown Talus (Fine / Medium Mix)..... | 3.6 in ³ (58.9 cm ³) |
| Gray Blend Ballast (Medium Grade)..... | 3.6 in ³ (58.9 cm ³) |

NOTE: Keep box to create the CARDBOARD BASE in Terrain Frame section. Verify kit contents before beginning construction.

Additional modeling supplies needed to complete this diorama.

- Black Spray Paint and Primer **or** Black Latex Paint, Primer and Paint Roller
- Dish for Water
- Disposable Cups (for mixing Lightweight Hydrocal and Liquid Pigments)
- Eyedropper
- Foam Tack Nails (ST1432)
- Hobby Knife
- Masking Tape
- Measuring Spoons
- Newspaper
- Paintbrushes (1/2" and 1" wide)
- Sandpaper (Fine Grade)
- Scenic Glue™ (S190) or white glue
- Scissors
- Straightedge

**Hydrocal is a U.S. Gypsum Registered Trademark*

IMPORTANT: READ THROUGH INSTRUCTIONS COMPLETELY BEFORE BEGINNING CONSTRUCTION.

TERRAIN FRAME

Assemble the Hardboard Side Frames to form the Terrain Frame. Check illustrations carefully during assembly. Let glue dry completely before moving to the next construction step.

SIDES AND FRAME SUPPORTS

1. The two shorter, in length, sections of Hardboard are the sides of the Terrain Frame (**Fig. 1**).

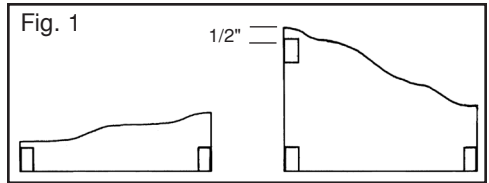

2. Sand rough burrs off of the five Corner Blocks, being careful to keep them square.

3. Use Scenic Glue to attach a Corner Block at each lower corner of the Hardboard (**Fig. 1**). The edges of the Corner Block should be even with the Hardboard. Use the fifth Block to check for evenness, by holding it against each side of the Hardboard and butting it up against the glued Blocks (**Fig. 2**).

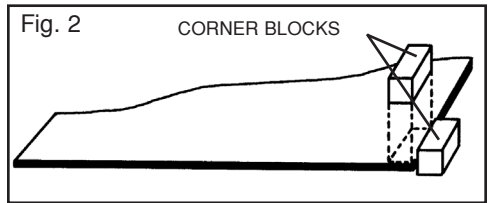

4. Glue the fifth Block at the top corner of the tallest side, having one side even with the edge of the Hardboard. The top of this Block should be about 1/2" below the contour of the side (**Fig. 1**).

5. Allow to dry.

FRONT AND BACK SECTIONS

1. The two longer sections of Hardboard are the front and back of the diorama (**Fig. 3**).

2. Beginning at the back, generously apply Scenic Glue along the inside edge of the back Hardboard section and along the Corner Block of a side section. In the upright position, press pieces together. Make sure the edges are even and square. Place several strips of masking tape over glue joints to hold pieces in place until glue dries (**Fig. 3**).

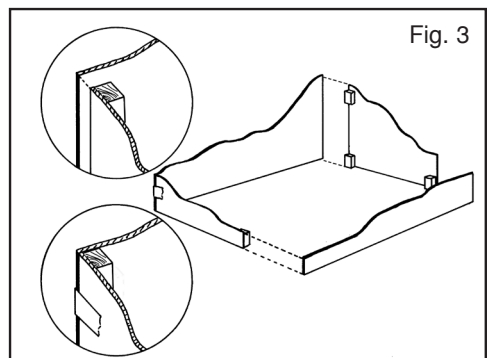

3. Continue in this manner until Terrain Frame is complete. Make sure the Frame is squared on each corner.
4. Allow glue to dry completely before removing masking tape strips.

CARDBOARD BASE

NOTE: Use *The Scenery Kit* box.

1. Using a hobby knife, cut one corner seam and lay box flat.

2. Place the Terrain Frame on the cardboard. Trace the inside perimeter onto the cardboard (**Fig. 4**). Remove the Frame.

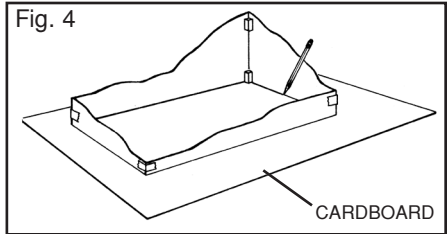

3. Using a straightedge and hobby knife, cut out the traced pattern.

4. Insert the cardboard into the Frame from the top (**Fig. 5**). The cardboard should rest on the tops of the four Corner Blocks (**Fig. 5**). If necessary, trim for perfect fit.

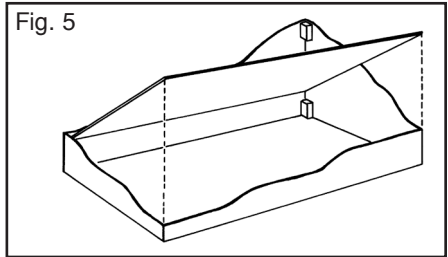

5. If needed, add strips of masking tape to hold cardboard in place.

6. With cardboard in place, turn Terrain Frame over and run a line of glue along the edge of the cardboard where it meets the Hardboard.

7. Allow glue to dry.

SUB-ROADBED

1. Place the precut Hardboard Sub-Roadbed smooth side up.

2. Using the Sub-Roadbed as a template, cut the Track-Bed strip with a hobby knife (**Fig. 6**). Trim ends of Track-Bed to match angles of Sub-Roadbed. Set Track-Bed aside for a later use.

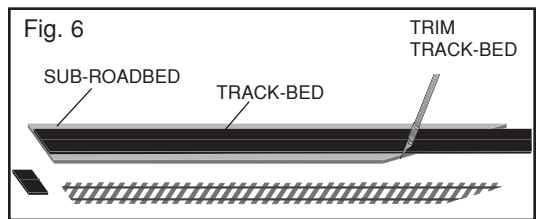

3. Apply glue to the ends of the Sub-Roadbed and attach inside the front and left sides of the Frame (**Fig. 7**). The top of the Sub-Roadbed piece should be even

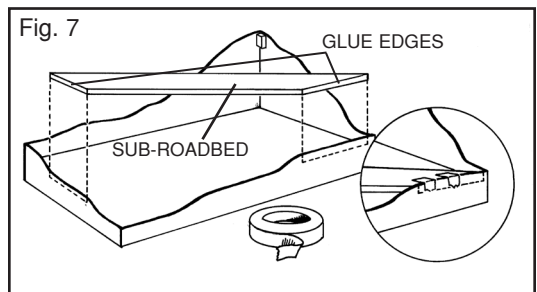

with the top of the Frame. Use strips of masking tape to hold the Sub-Roadbed in place until the glue dries (**Fig. 7**).

TIP! Place a small bottle or other item under the Sub-Roadbed to hold it in place while it dries.

4. When dry, carefully remove the masking tape.

SANDING AND PAINTING

1. Using fine grade sandpaper, smooth the rough edges of the Terrain Frame.

NOTE: The Sub-Roadbed does not need to be sanded because it will be covered with Plaster Cloth.

2. Apply an even coat of primer on the outside of the Terrain Frame. Allow to dry, then sand lightly.

3. When dry, use a damp rag to wipe off dust. Apply a flat or satin black paint over the primer. When dry, apply a second coat if needed. A third coat may be applied after diorama is complete.

TERRAIN

For the best use of the enclosed materials, try to make your diorama similar to the illustrations and the photo on the box.

Terrain can be defined as the earth contours or physical features of a tract of land. Terrain can include rolling hills and broad valleys, mountains and narrow canyons, flat plateaus and undulating prairies. When building a model railroad layout, the terrain is the first feature added after the bench work construction and track have been completed.

When you build a module or large layout, you have almost unlimited choices in the type of terrain you build. You can model a particular area or create imaginary scenery. The techniques you learn with this diorama can be applied to any size layout or model.

NEWSPAPER WADS

1. To create newspaper wads, begin with a full-size sheet of newspaper. Roll edges under in a circular motion, creating a pillow shape (**Fig. 8**). The pillow shape is easy to stack when forming terrain.

2. Stack wads to form terrain shape and hold in place with masking tape (**Fig. 9**). Use smaller newspaper wads in front and behind the Sub-Roadbed. Push newspaper wads under the Sub-Roadbed to help hold the other wads in place.

3. Form a shallow ditch along the back of the Sub-Roadbed, by placing smaller newspaper wads lower in this area (**Fig. 12**, pg. 6).

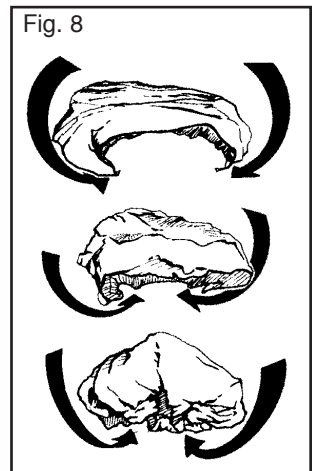

4. Newspaper wads should create a gentle slope which follows the contours of the back, sides and front of the Terrain Frame. However, it should be no higher than the Frame.

5. Test fit the Rock Castings and Track to be sure there is sufficient clearance for the train engine or rolling stock you intend to display (**Fig. 17**, pg. 8). If you have too many newspaper wads, make adjustments.

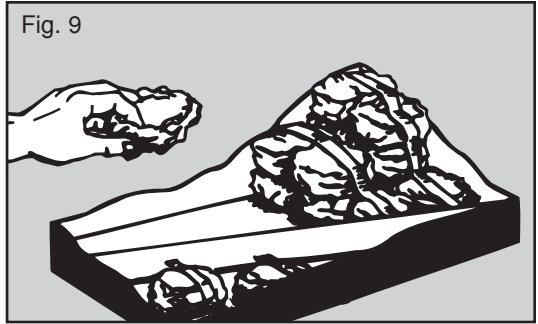

NOTE: The Track section included with this kit is HO scale. The kit can be adapted to O scale or smaller, by substituting your own section of track. Be sure to check track clearances carefully for scales larger than HO. If you plan to display something other than railroad equipment, such as a military model, substitute a road for the track (see TRACK AND BALLAST in Landscape Section).

PLASTER CLOTH

Plaster Cloth is applied on top of the newspaper wads to create a hard terrain surface.

1. Use scissors to cut the Plaster Cloth into 3" strips.

2. Apply Plaster Cloth beginning on the left side of the diorama and working toward the right. Hold a Plaster Cloth strip by the corners and briefly dip in water. Lay wet Plaster Cloth on newspaper wads, **bumpy side up**. Smooth each strip of Plaster Cloth with wet fingers to fill holes in Cloth. Press and smooth Plaster Cloth into indented areas to highlight terrain contours. Overlap previous strip by 50% until newspaper wads are covered. (**Fig. 10**)

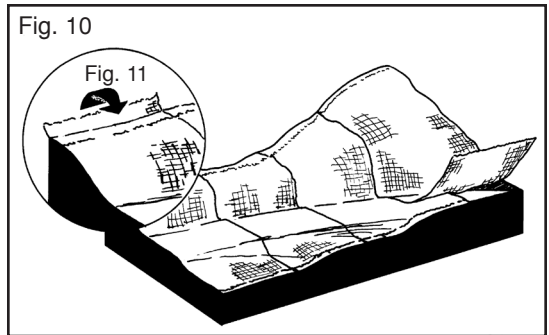

Edging: Apply Plaster Cloth along the edge of the diorama: extend wet strip of Cloth approximately 1" over the edge of the Frame, then fold it back on itself (**Fig. 11**). Smooth Cloth with wet fingers.

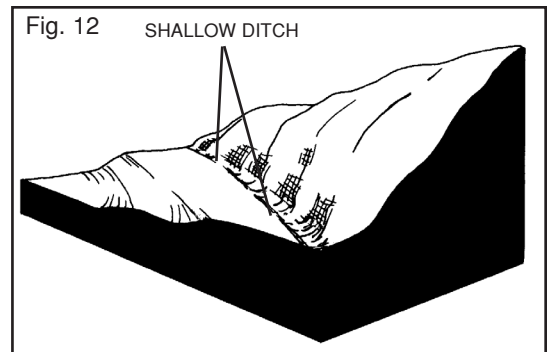

3. Save a few strips of Plaster Cloth to use later with the Culvert and Rock Castings.
4. Allow Plaster Cloth to dry.

CULVERT ASSEMBLY AND INSTALLATION

NOTE: Separate Rock Colors by cutting plastic connectors.

1. Remove any rough edges from the Culvert pieces with a hobby knife and fine grade sandpaper. Trial fit pieces as you smooth the edges (**Fig. 13**).

2. Color Culvert pieces before assembly. Using a small disposable cup, mix 1/8 teaspoon Black Rock Color and 4 teaspoons of water to create a Black Wash. Mix thoroughly with a Stir Stick. Place Culvert pieces on paper towels so front and sides can be colored.

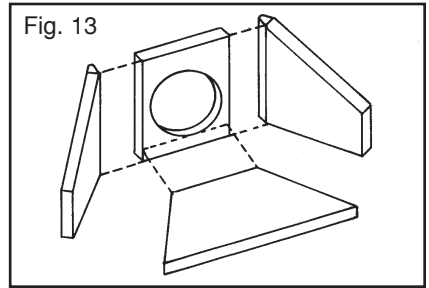

3. Dab Black Wash on Culvert pieces with Foam Applicator until an even color is achieved. Allow pieces to dry. Save remaining Black Wash for coloring Rock Castings. Wash the Foam Applicator. **NOTE:** If color is too dark, color can be lightened by flood-spraying the area with hot salt water (1 tsp salt in 6 oz water).

4. When Culvert pieces are dry, assemble and glue (**Fig. 13**). Keep glue off detailed surface. Hold firmly in place until setting begins. Allow glue to dry completely before installing on layout.

5. Place completed Culvert where it will be installed, then trace around the outside (**Fig. 14**). Use a hobby knife to cut and shape terrain for proper fit (**Fig. 15**). The Culvert should fit snugly into the embankment beneath the track.

6. Install Culvert Assembly with Lightweight Hydrocal. In a disposable container, slowly add 2 1/2 teaspoons of Lightweight Hydrocal into 1 teaspoon of water. Let stand for 2 minutes, then mix thoroughly with a Stir Stick for 1 minute.

7. When using Lightweight Hydrocal as an adhesive, connecting surfaces must be wet. Dip Culvert in water and spray area with water where Culvert will be installed. Using a Stir Stick, apply Hydrocal generously to the backside of the Culvert and attach it to diorama. Keep Lightweight Hydrocal off detailed surface. Hold in place until setting begins (approx. 3-4 minutes).

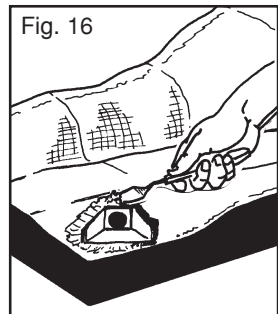
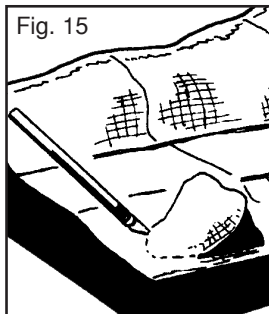
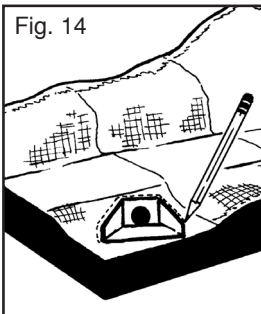

8. Spread Lightweight Hydrocal around edges of Culvert to fill gaps between terrain (**Fig. 16**). Allow to dry.

9. Wash measuring spoons and Stir Stick before Lightweight Hydrocal has set. Do not wash excess Hydrocal down the drain.

INSTALL ROCK CASTINGS

1. Trial fit Rock Casting on terrain surface (**Fig. 17**). You may need to cut and shape terrain for Rocks to fit properly (**Fig. 18**).

2. Add 10 teaspoons of Lightweight Hydrocal into 4 teaspoons of water. Let stand for 2 minutes, then mix thoroughly with a Stir Stick for 1 minute.

3. Briefly soak Rock Casting in water and spray water on the Plaster Cloth terrain where Castings will be attached.

4. Generously spread Lightweight Hydrocal on the back of Rock Castings and press in place. Hold in place until setting begins.

5. Spread Lightweight Hydrocal around edges of Rock Castings to fill gaps between terrain. Using a paintbrush dipped in water, smooth and blend with terrain. Keep Lightweight Hydrocal off Rock surfaces.

6. If you still have gaps between the Culvert or Rock Castings and terrain, place small strips of wet Plaster Cloth around edges (**Fig. 19**). Smooth Plaster Cloth with wet fingers to blend with terrain. Try to make the terrain flow smoothly between the Culvert and Rock Castings.

7. Allow to dry.

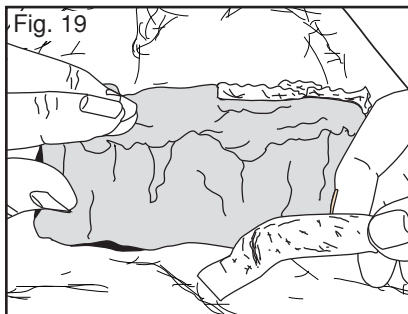
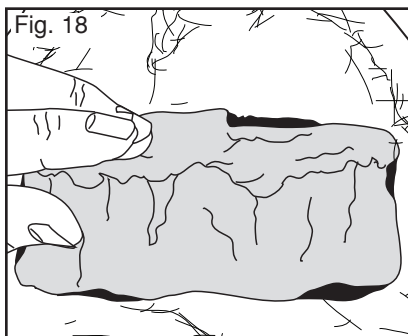
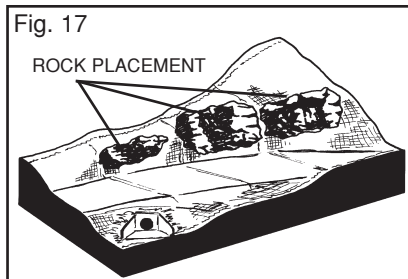

COLOR ROCK CASTINGS

Color Rock Castings with a technique called “Leopard Spot.”

1. Dilute Yellow Ocher and Burnt Umber pigments with water to create color washes. Mix 1/4 teaspoon of each color with 4 teaspoons of water in separate disposable cups. Mix thoroughly with a Stir Stick.

2. Dip Foam Applicator in Yellow Ocher Wash. Dab Color Wash in random spots on Rock Castings (**Fig. 20**). Rinse Foam Applicator. Randomly dab Burnt Umber on a separate area on Rock Castings. Dabbing Color Washes in a leopard spot pattern will produce many varying shades and hues of color. Allow the Washes to naturally run

and overlap on the Rock Castings. Leave some areas on Rock Castings white.

3. Mix 1/8 teaspoon Black Rock Color and 4 teaspoons of water to create Black Wash. Using the Foam Applicator, brush and dab Black Wash over entire Rock Casting surfaces letting it run into the cracks and crevices. This will tie colors together. Let dry completely. **NOTE:** If you want darker shades, dip Foam Applicator in water then in the undiluted Black Rock Color and dab on the rock castings.

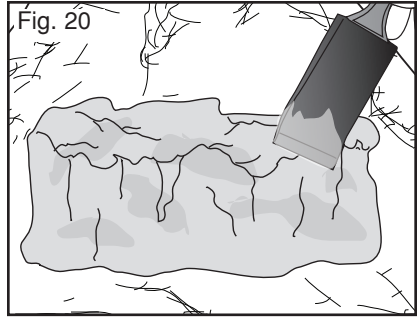

6. Shake bottle of Scenic Cement to mix, then attach Spray Head. Spray Scenic Cement on the Culvert and Rock Castings to set the color. Let dry.

OPTION: Save remaining Rock Colors for coloring Talus.

FLYSPECKING

Add texture and realism by modeling the dirt and soil which collects on rocks with a technique called “flyspecking.”

1. Mist Rock Castings lightly with Scenic Cement.

2. Bend a sheet of paper into an “L” shape. Place a small amount of Soil Fine Turf on the horizontal section of the paper. Hold the paper near the Rock Castings and gently puff air on the vertical section of the paper (**Fig. 21**). This will blow “flyspecks” of Soil onto the Rock Castings. If you have too much Soil on Castings, brush off with a dry paintbrush.

3. Mist again with Scenic Cement to seal.

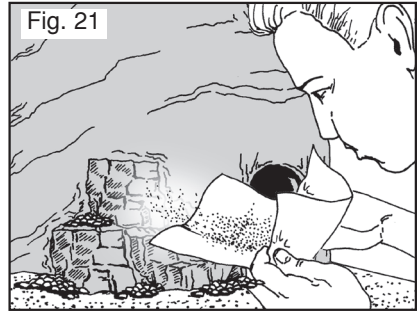

EARTH UNDERCOAT

1. Empty entire container of Earth Undercoat into a disposable cup. Fill empty Earth Undercoat bottle with water and mix with Earth Undercoat.

2. Using a 1” wide paintbrush, brush Earth Undercoat over entire terrain surface, **avoiding** the Culvert and Rock Castings. An opaque layer is not needed, just enough to cover the white plaster. If necessary, use a damp sponge or paper towels to clean any Earth Undercoat off the outside of the Hardboard base. Let dry.

LANDSCAPE

After the contours on the diorama are complete, the next step is to add landscape. This process adds color, texture and realism to the diorama as you model various types of vegetation.

NOTE: There is no specific order in which many of the landscape materials are added to dioramas or layouts. In this diorama we will present one method, but feel free to alter it if you wish or return to an earlier section to add more of a particular product. However, the best use of enclosed materials can be obtained by following the steps closely.

TRACK AND BALLAST

NOTE: If you are making this diorama to display something other than model railroad items, do NOT add the Track and Ballast. Instead, make the Sub-Roadbed area into a road or cover it with Turf material. Proceed to LOW GROUND COVER.

1. Spread Hob-e-Tac on backside of Track-Bed with the brush applicator. Allow Hob-e-Tac to become clear and tacky (approx. 15 minutes, drying times vary). When tacky, carefully align Track-Bed on Sub-Roadbed and press in place.

2. Trial fit strip of Track on Track-Bed. Make needed adjustments.

3. Spread Hob-e-Tac on top of Track-Bed and wait until clear and tacky. Press Track in place. Set weights on the Track or use Foam Nails (ST1432) to hold in place while Hob-e-Tac dries. **NOTE:** Track-Bed and Track can also be attached with Scenic Glue (S190) or Foam Tack Glue (ST1444). Save some Hob-e-Tac to make trees and attach Field Grass.

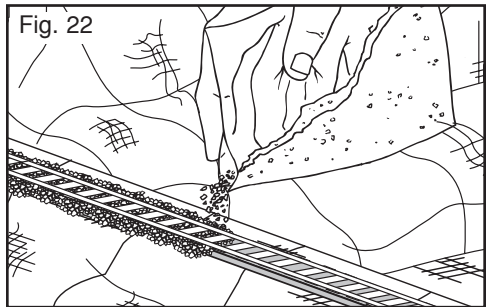

4. Open Ballast and pour an even amount over Track (Fig. 22). Spread the Ballast evenly with a dry paintbrush until it is even with the ties (Fig. 23). Soak Ballast with Scenic Cement (Fig. 24), avoiding contact with the track. Let dry.

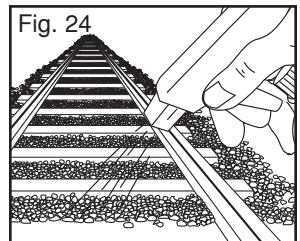
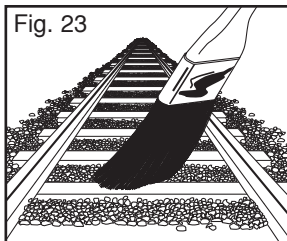

LOW GROUND COVER

1. Cut off a corner of the Green Blend Blended Turf bag. Working in one small area at a time, generously spray terrain base with Scenic Cement. While wet, sprinkle on a fairly thick coating of Blended Turf (Fig. 25). Apply to all areas of diorama except for

Culvert, Track and Rock Castings.
Let dry.

TIP! Cover these areas with a sheet of paper when spraying Scenic Cement.

2. Gently blow off any excess Blended Turf which is not attached to diorama.

3. Cut off a corner from each bag of Fine Turf colors: Burnt Grass, Yellow Grass, Earth and Soil.

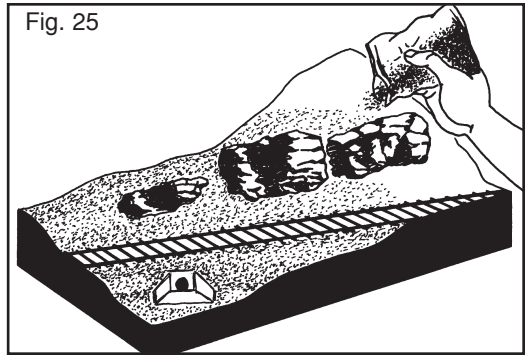

4. Overspray Blended Turf with Scenic Cement and lightly sprinkle on Fine Turf colors in a salt and pepper fashion as accent colors. Use these accent colors more sparingly than the Green Blend Blended Turf. Blend the accent colors into each other to avoid splotches of color. If you feel you have added too much of one color, just sprinkle another color in a salt and pepper style. When you are satisfied with the coloring, lightly overspray with Scenic Cement to permanently attach.

TIP! Burnt Grass provides a variation in the basic green coloring. Yellow Grass can indicate areas which do not get much water, such as the sides of slopes. Earth and Soil can be used to make a path, or indicate bare spots of ground.

5. Use a damp sponge or paper towels to clean off any Scenic Cement on the Hardboard sides.

NOTE: If you are using the diorama for something other than a model railroad display, you may wish to use the Earth or Soil Fine Turf to create a dirt road on the sub-roadbed area. Simply spray area with Scenic Cement, then shake on the Turf in a fairly heavy layer. Gently blow off any Turf that is not attached after Scenic Cement dries.

ASSEMBLE TREES

Build trees now and set them aside for placement on the diorama later.

1. Remove Tree Armatures from optional bases.
2. Twist and bend Tree Armatures into realistic, three-dimensional shapes (**Fig. 26**).
3. Using the brush applicator, liberally apply Hob-e-Tac on both sides of branches,

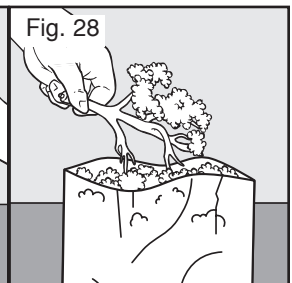
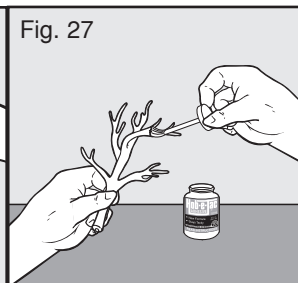
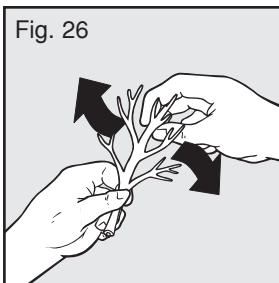

avoiding areas where foliage does not naturally grow (**Fig. 27**). Place Tree Armatures in optional bases until adhesive becomes clear and tacky (approx. 15 minutes, drying times vary).

4. Dip Armatures into bag of Clump-Foliage (**Fig. 28**), then firmly pinch on branches to adhere. If desired, use both colors of Clump-Foliage.

5. Spray completed trees with Scenic Cement to secure foliage. Sprinkle on Yellow Grass Fine Turf for highlights and spray again with Scenic Cement. Set the trees aside for planting later.

MEDIUM GROUND COVER

Medium Green Coarse Turf provides texture variation and can model weeds, coarse grass and small plants.

1. Spray random areas of Blended Turf with Scenic Cement, then sprinkle with Coarse Turf. Overspray with Scenic Cement to seal.

2. Create bushes with remaining Clump-Foliage. Apply Scenic Glue where you would like bushes (**Fig. 29**). Press pieces of Clump-Foliage into glue (**Fig. 30**). If desired, mix the two colors of Clump-Foliage. Bunch the Clump-Foliage pieces together to indicate groups of bushes (**Fig. 31**). **NOTE:** Bushes grow naturally in groups, not as individual plants.

3. Mist bushes with Scenic Cement. Sprinkle Burnt Grass and Yellow Grass Fine Turf lightly on bushes for highlights.

4. Use Poly Fiber to model vines and low ground cover plants. Pull off a small amount of Poly Fiber, then stretch until thin and lacy. Attach with Scenic Glue (**Fig. 32**). Spray with Scenic Cement, then sprinkle with Burnt Grass or Yellow Grass Fine Turf to add leaf structure and color variations.

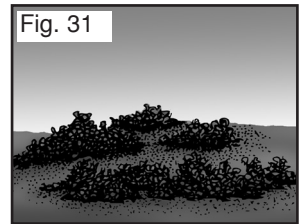
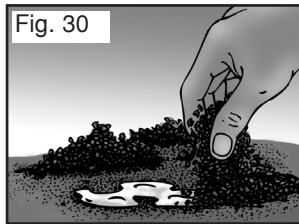

TALUS

Talus is the rock debris which collects beneath cliffs around the base of mountains and near water areas.

1. Shake bag of Talus to mix. Cut a corner of the bag and sprinkle on desired locations. Add Talus below the Rock Castings where rock debris would naturally occur (**Fig. 33**).

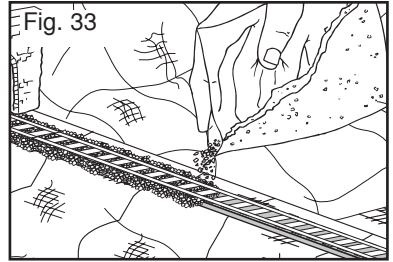

2. To attach, spray Talus heavily with Scenic Cement. For hard to reach areas, apply Scenic Cement with an eyedropper (**Fig. 34**). Let dry, then apply another coat of adhesive in the same manner. Let dry.

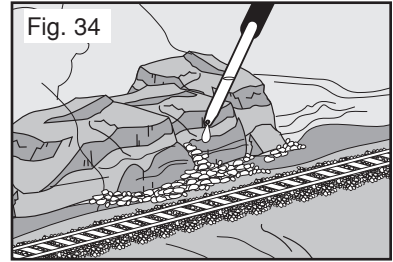

OPTION: Color Talus to resemble Rock Castings. Add some Talus to each Color Wash. Let soak 1 hour or until desired color is achieved. Let dry on paper towels. If Talus is too dark, spray with water to lighten.

TIP! Place Talus along the top of the rock outcroppings, at rock ledges, along the back of the Track and around the Culvert. Refer to the box photo for more ideas.

HIGH GROUND COVER

1. Place a small amount of Hob-e-Tac on a piece of scratch paper. Remove a pinch of Field Grass from package. Roll between fingers to create an uneven, natural look. Using scissors, cut Field Grass to preferred length (**Fig. 35**). Dip cut end in Hob-e-Tac (**Fig. 36**), then place on diorama (**Fig. 37**). Hold in place until setting begins. Continue adding random clumps of Field Grass in a variety of locations.

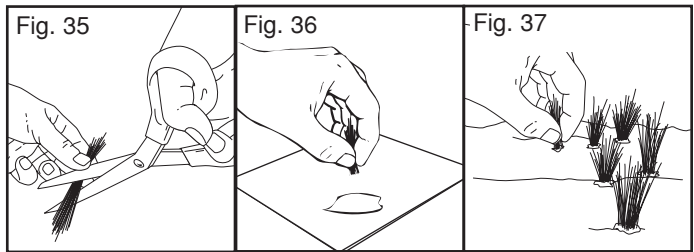

2. With the tip of a hobby knife, make a tiny hole in the terrain shell where you would like to plant a tree. Apply Hob-e-Tac or Scenic Glue over the hole. Press tree into hole (**Fig. 38**). Repeat with the other trees.

TIP! To blend trees with landscape, glue leftover pieces of Clump-Foliage around the base of trees.

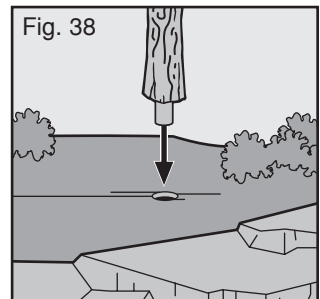

FINAL STEP

SCENIC CEMENT

1. Apply a final, heavy coat of Scenic Cement over entire diorama. Let dry.

IDEAS

DRYBRUSH TURF

There may be areas on your diorama where you would like to add color variation, add more color, cover up splotches of glue or plaster or disguise some undesirable feature. Drybrushing with Turf is an easy way to do this!

1. Apply desired color(s) of Turf with a dry paintbrush. When you like the look, mist lightly with Scenic Cement to seal Turf in place.

IDEAS: Add Soil or Earth Fine Turf on top of Talus or along edges of Ballast to model weeds and grasses. Apply Burnt Grass Fine Turf around the base of the Field Grass to cover Hob-e-Tac Adhesive.

ADDING ADDITIONAL LANDSCAPE MATERIALS

Add some additional landscape materials for a variety in texture or color, to add more realism or to create more interest in the scenery.

1. Add additional Coarse Turf, Clump-Foliage bushes, Poly Fiber ground cover or Field Grass.
2. Overspray landscape materials lightly with Scenic Cement, then sprinkle on Burnt Grass or Yellow Grass Fine Turf to provide color variations.

FLYSPECKING TURF

Dirt and soil collects in many areas including rock faces, on top of Ballast and Talus and on Turf areas.

1. Use the “flyspecking” technique to add Soil Turf to these areas.

TOUCH UP BLACK PAINT

1. Hide terrain materials that are visible through the opening in the Culvert. Using a small paintbrush, carefully apply undiluted Black Rock Color to any material which is visible.
2. The Hardboard Frame may need a coat of touch-up paint. Roll or brush a coat of black latex paint as needed.
3. After diorama has dried completely, place your engine, piece of rolling stock or other model. It is now ready for display!

To view How-To videos and find more Tips and Techniques for using the Terrain and Landscape products included in this kit, visit www.woodlandscenics.com.

While on the Web site, check out other learning aids available for purchase. Model Scenery Made Easy (DVD R973) video is a comprehensive, detailed account of how to model realistic scenery. In The Clinic video (DVD R970), some of the best professionals in the model railroading business demonstrate terrain and landscape techniques to a standing room only crowd at a National Model Railroad Association convention. For a convenient tableside reference, purchase The Complete Guide to Model Scenery (C1208). From the layout base to scenery to the final details, learn the secrets to using more than 600 products to model realistic layouts. You may also enjoy one of our Learning Kits (LK951 – LK957). In addition to learning more about modeling rock formations, landscape and trees, these learning kits teach modelers how to add roads, paved areas, lakes, rivers and waterfalls to any layout.

We hope you have enjoyed your modeling experience with The Scenery Kit. If you wish to purchase more of the materials included in this kit, the following list provides the product information.

| <u>DESCRIPTION</u> | <u>PRODUCT NUMBER</u> |
|-----------------------------|-----------------------|
| Gray Blend Ballast | B94 |
| Lightweight Hydrocal® | C1201 |
| Plaster Cloth | C1203 |
| Black Liquid Pigment | C1220 |
| Burnt Umber Liquid Pigment | C1222 |
| Yellow Ocher Liquid Pigment | C1223 |
| Earth Undercoat Pigment | C1229 |
| Random Rock Rock Mold | C1234 |
| Concrete Culvert | C1262 |
| Fine Brown Talus | C1274 |
| Medium Brown Talus | C1275 |
| Medium Green Clump-Foliage™ | FC183 |
| Dark Green Clump-Foliage™ | FC184 |
| Green Poly Fiber | FP178 |
| Light Green Field Grass | FG173 |
| Scenic Cement™ | S191 |
| Scenic Sprayer™ | S192 |
| Hob-e-Tac® Adhesive | S195 |
| Soil Fine Turf | T41 |
| Earth Fine Turf | T42 |
| Yellow Grass Fine Turf | T43 |
| Burnt Grass Fine Turf | T44 |
| Green Blend Blended Turf | T49 |
| Medium Green Coarse Turf | T64 |
| Realistic Tree Kit | TR1101 |
| Track-Bed™ | ST1471 |



WOODLAND SCENICS®
PO BOX 98, LINN CREEK, MO 65052
www.woodlandscenics.com