

**RIVER PASS™ HO SCALE**

# **LAYOUT KIT**

ST1484

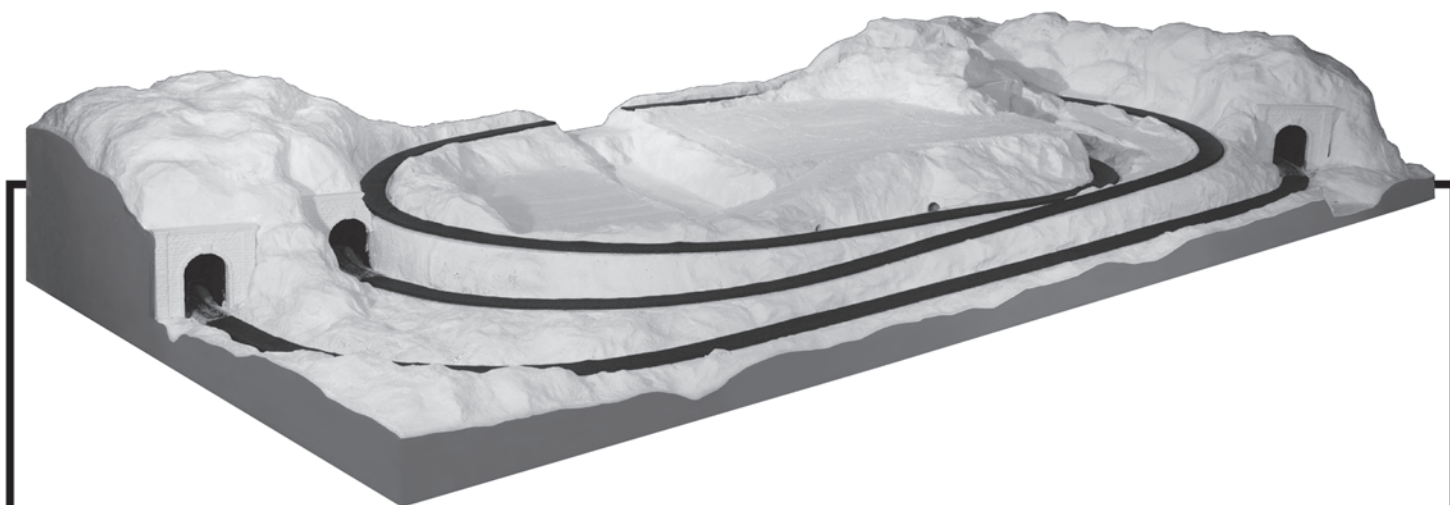

**INSTRUCTION BOOKLET**



**WOODLAND SCENICS®**

# Contents

<b>Introduction</b> .....	<b>2</b>	<b>Upper Tier Track Supports</b> .....	<b>13</b>
<b>Kit Contents</b> .....	<b>3</b>	<b>Tunnel Roof and Platforms</b> .....	<b>14</b>
<b>Suggested Tools</b> .....	<b>3</b>	Cut Foam Sheets to Create Flat Areas .....	14
<b>Track</b> .....	<b>3</b>	Test Fit Buildings .....	14
<b>Adhesives and Special Tools</b> .....	<b>3</b>	<b>Road Foundation</b> .....	<b>15</b>
Foam Tack™ Glue .....	3	Add Road Foundation .....	15
Low Temp Foam Glue Gun and Glue Sticks .....	3	<b>Wiring</b> .....	<b>15</b>
Hot Wire Foam Cutter .....	3	Method 1 .....	15
<b>Layout Overview</b> .....	<b>4</b>	Alternate Method .....	15
<b>Begin Layout Assembly</b> .....	<b>5</b>	<b>Add Plaster Cloth and Track-Bed™</b> .....	<b>16</b>
Assemble Base Panels .....	5	Make and Place Newspaper Wads .....	16
Test Fit Track .....	5	Plaster Cloth .....	17
<b>Install Risers and Inclines/Declines</b> .....	<b>6</b>	<b>Plaster Cloth Sides of Layout</b> .....	<b>17</b>
Install First Tier Risers .....	6	Test Track .....	17
Install Second Tier Inclines/Declines .....	7	<b>Lay Track-Bed</b> .....	<b>18</b>
<b>Tunnel Work</b> .....	<b>8</b>	Glue Down Track .....	18
Plaster Cloth Inside Tunnel Areas .....	8	<b>Install Tunnel Portals and Culverts</b> .....	<b>18</b>
Test Fit Track and Lay Track-Bed Inside Tunnel Areas .....	8	Install Tunnel Portals .....	18
Place Track and Ballast Inside Tunnel Areas .....	9	Install Culverts .....	19
Place Foam Tunnel Portals .....	9	<b>Base Paint</b> .....	<b>19</b>
Tunnel Walls .....	10	<b>Products</b> .....	<b>19</b>
<b>Profile Boards™</b> .....	<b>11</b>	<b>Complete Your Layout</b> .....	<b>19</b>
Cut Access Panels .....	11	<b>Track Plan</b> .....	<b>20</b>
Cut and Assemble Profile Boards .....	12		
Fill Corner Joints .....	12		

# Introduction

The Woodland Scenics River Pass Layout Kit has all the materials needed to build a 4x8-foot HO scale base and terrain for any layout. Materials include Inclines/Declines, Risers, Foam Sheets, Track-Bed, Ballast for tunnel areas, Portals, Culverts and Plaster Cloth. To make assembly as easy as possible, the track plan has been printed on the base and the Profile Boards are printed with the contours.

Before you begin, you should make sure that you have the common household items necessary for building the kit (listed under Suggested Tools). We also recommend purchasing a Woodland Scenics Low Temp Foam Glue Gun (ST1445) and Glue Sticks (ST1446). Another tool that can make building the River Pass Layout Kit easier is the Woodland Scenics Hot Wire Foam Cutter (ST1435), which is used to cut and shape the foam.

Woodland Scenics Systems are designed to give plenty of room for error so modelers can always go back and fix a problem later.

The Risers and Inclines/Declines allow for elevation of the track above the base of the layout, which makes it easy to add ditches, creeks and low-lying areas without cutting into the base. Inclines/Declines also add grades to your layout so that your train may climb and descend hills. With our Inclines/Declines, you have no complicated calculations to make.

**NOTE:** Remember, as you cut the foam Profile Boards and Foam Sheets, it is important to save all extra scrap foam pieces until you are done with the project as you will use the scraps to assemble your layout.

**We recommend reading through each section as you come to it before you begin the steps so you will understand the sequence. We have included informative illustrations to help you see each step as you begin building the layout.**

Description	Quantity
Profile Boards (printed) 8 in x 24 in (20.3 cm x 60.9 cm) ea	11
Profile Board Connectors	5
Printed Foam Base Panels 1/2" x 24" x 48" (1.27 cm x 60.9 cm x 121 cm) ea	4
1/4" Foam Sheets 1/4" x 12" x 24" (6.35 mm x 30.4 cm x 60.9 cm) ea	7
1/2" Foam Sheets 1/2" x 12" x 24" (1.27 cm x 30.4 cm x 60.9 cm) ea	5
1" Risers 1" x 2 1/2" x 24" (2.54 cm x 6.35 cm x 60.9 cm) ea	4
2" Risers 2" x 2 1/2" x 24" (5.08 cm x 6.35 cm x 60.9 cm) ea	21
3% Incline/Decline pieces - 2 1/2" W X 24" L (6.35 cm x 60.9 cm) 1 each: 0" - 3/4" (1.9 cm), 3/4" - 1 1/2" (1.9 cm - 3.81 cm) and 1 1/2" - 2 1/4" (3.81 cm - 5.71 cm) 2 each: 2 1/4" - 3" (5.71 cm - 7.62 cm), 3" - 3 3/4" (7.62 cm - 9.52 cm), and 3 3/4" - 4 1/2" (9.52 cm - 11.4 cm)	9
4% Incline pieces - 2 1/2" W X 24" L (6.35 cm x 60.9 cm) 1 each: 1" - 2" (2.54 cm - 5.08 cm) and 2" - 3" (5.08 cm - 7.62 cm) 3 each: 0" - 1" (2.54 cm)	5
HO Scale Track-Bed Roll 3/16" x 1 3/4" x 24' (5 mm x 4.44 cm x 7.31 m) ea	2
Plaster Cloth Rolls 8" x 30', 20 ft <sup>2</sup> (20.3 cm x 9.14 m, 1.85 m <sup>2</sup> ) ea	6

Description	Quantity
Foam Nails 2" (5.08 cm)	75
Buff Medium Ballast	10.8 in <sup>3</sup> (176 cm <sup>3</sup> )
Scenic Cement™	.8 oz (236 mL)
Scenic Cement Sprayhead	1
Foam Pad	1
HO Scale Culverts, Random Stone	8
HO Scale Tunnel Portals, Single Cut Stone (1 broken into two pieces)	4
Foam Tack™ Glue	16 fl oz (473 mL)
Gray Base Paint	12 fl oz (354 mL)
Black Tunnel Paint	1.84 fl oz (54.4 mL)
Black Foam Pencil	1
Black Construction Paper 4 1/2" x 7 3/4" (11.4 cm x 19.6 cm)	1

\*Extra 2 1/4" to 3" Incline/Decline included!

## Suggested Tools

- ADDITIONAL ITEMS NEEDED BUT NOT INCLUDED**
- masking tape
  - graduated measuring cup
  - hobby knife or Foam Knife (ST1433)
  - Scenic Sprayer™ (S192)
  - scissors
  - drinking straw or eyedropper
  - track (see below)
  - Hot Wire Foam Cutter (ST1435)(optional)
  - newspaper
  - pan for water
  - straightedge, ruler or yardstick
  - Tidy Track® Rail Pal™ (TT4575) (optional)
  - liquid detergent
  - paint brush 1 1/2" – 2" wide
  - Low Temp Foam Glue Gun (ST1445) and Glue Sticks (ST1446) (optional)
  - disposable bowl
  - awl or small drill bit
  - large piece of cardboard (2' x 3')

## Track

### TRACK NEEDED FOR LAYOUT

A. 9" STRAIGHT	17 pcs
B. Full Section 18" Radius	34 pcs
C. 6" STRAIGHT	5 pcs
D. 3" STRAIGHT	3 pcs
E. 1/3 18" Radius	2 pcs
F. Snap Switch left - remote	1 pc
G. Snap Switch right - remote	1 pc
H. Warren Truss Bridge	1 pc

All types of track have their advantages depending on your experience and expectations. Choose your track according to the TRACK NEEDED FOR LAYOUT information. **NOTE:** When assembling track, it is important to remember that once the Risers are in place the track does not have to be centered exactly with the Risers. Just make sure the track is correctly assembled and the train functions properly.

## Adhesives and Special Tools

Woodland Scenics offers two different kinds of adhesives for SubTerrain Lightweight Layout System® products. Each has advantages for different jobs. General instructions for using both of these products appear below. *These instructions are written for, and Woodland Scenics strongly recommends, using the Low Temp Foam Glue Gun to complete the kit. If you decided to use the Foam Tack Glue, read this section and refer back to it as you are gluing the components together.* You can find the Low Temp Foam Glue Gun and the Hot Wire Foam Cutter at your favorite hobby shop or online at woodlandscenics.com.

### Foam Tack Glue (ST1444)

Foam Tack Glue is a specially formulated glue that is safe and easy to use with foam. Used properly, you can use it to assemble this entire kit. Foam Tack Glue is especially useful when gluing together thin or narrow pieces of foam. However, your work must remain pinned down with Foam Nails until the Foam Tack Glue dries (about 12 hours). Foam Tack Glue must be spread evenly over the surfaces being glued together, so you will have to unpin Risers, Inclines/Declines and other components in order to apply the glue.

If using Foam Tack Glue to secure the foam, follow these steps:

- Pin foam components in place to ensure positioning. Remove them individually to apply glue.
- Spread a thin layer of Foam Tack Glue on contact surface of foam and area where it will be placed.
- Replace component and pin it firmly in place. Repeat these steps for the entire layout.



### Low Temp Foam Glue Gun (ST1445) and Glue Sticks (ST1446)

The Low Temp Foam Glue Gun and Glue Sticks will not melt or damage foam components. Glue bonds almost instantly and is inexpensive. We recommend this product for gluing down Risers, Profile Boards and Foam Sheets. It sets much quicker than Foam Tack Glue and you will not have to disassemble your work to use it. However, it can cause lumps if used underneath thin materials like Incline/Decline Starters or Track-Bed. To use the Low Temp Foam Glue Gun and Glue, merely run a continuous bead at the seam of the materials you are bonding.



**Important: Do not use a high temperature glue gun on this kit. It can damage the foam components.**

### Hot Wire Foam Cutter (ST1435)

The Woodland Scenics Hot Wire Foam Cutter was designed for use with Woodland Scenics patented foam components. It is the quickest, easiest way to cut foam. An accessory you can buy, called the Bow and Guide (ST1437), makes the Hot Wire Foam Cutter even more versatile. Replacement Nichrome wire is also available.



**Bow and Guide**

# Layout Overview

1.

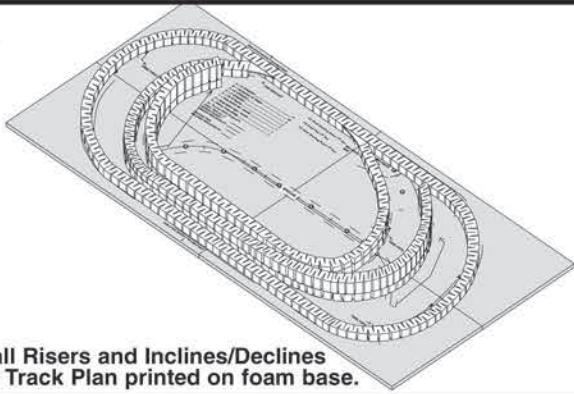

Install Risers and Inclines/Declines over Track Plan printed on foam base.

2.

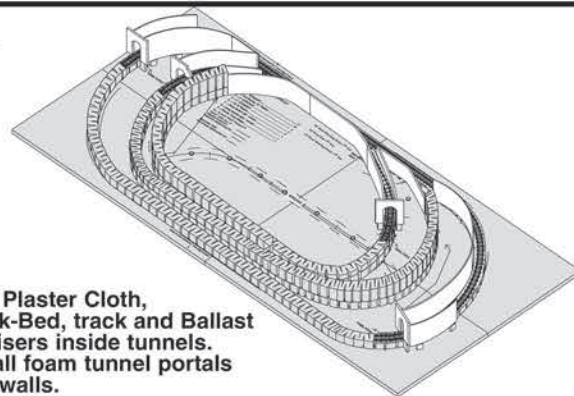

Add Plaster Cloth, Track-Bed, track and Ballast to Risers inside tunnels. Install foam tunnel portals and walls.

3.

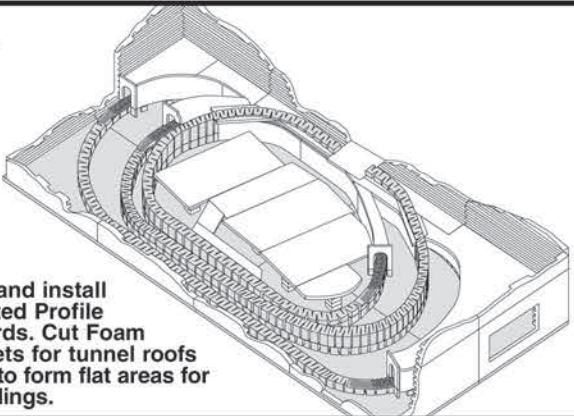

Cut and install printed Profile Boards. Cut Foam Sheets for tunnel roofs and to form flat areas for buildings.

4.

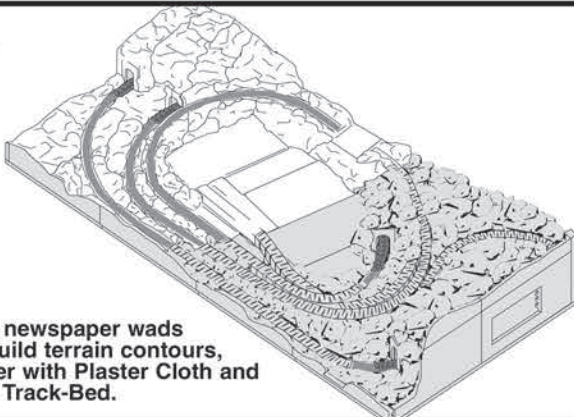

Use newspaper wads to build terrain contours, cover with Plaster Cloth and add Track-Bed.

Install Risers wherever track will be laid to raise the height of the track. Surrounding areas will be lower, making it easier to create creeks and other low-lying areas without cutting into the layout base.

**NOTE:** Make sure to install Risers with the zig-zag pattern facing up.



2" Riser

Use flexible Inclines/Declines to easily change track elevations on curves or straights. The SubTerrain System's pre-cut Inclines/Declines (with 2%, 3% or 4% grade) remove the guesswork and complicated calculations.



4% Incline/Decline Set

Install interlocking Profile Boards with matching Connectors to make a sturdy layout perimeter that can be cut easily with the Hot Wire Foam Cutter or a Foam Knife to conform to any profile desired.

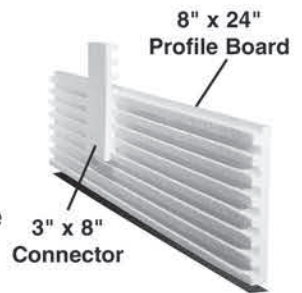

8" x 24" Profile Board

3" x 8" Connector

Cut Foam Sheets to enclose tunnels, create interior terrain profiles and form level, elevated areas for buildings and towns.

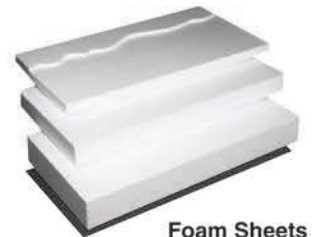

Foam Sheets

Form terrain with newspaper wads and cover with Plaster Cloth that has been dipped in water. The Plaster Cloth will dry to a hard shell without adding any plaster.



Plaster Cloth

Install Track-Bed for a quieter, smoother operation. Simply tack or glue down to easily attach Track-Bed. Track-Bed is flexible, requires no soaking, is compatible with cork and won't dry out or crumble.



Track-Bed

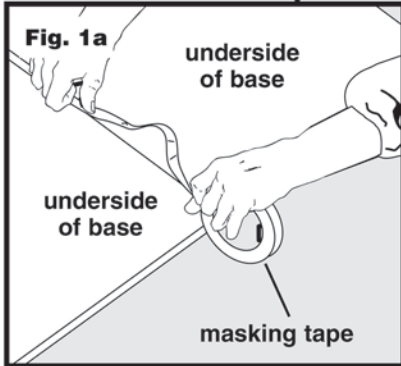
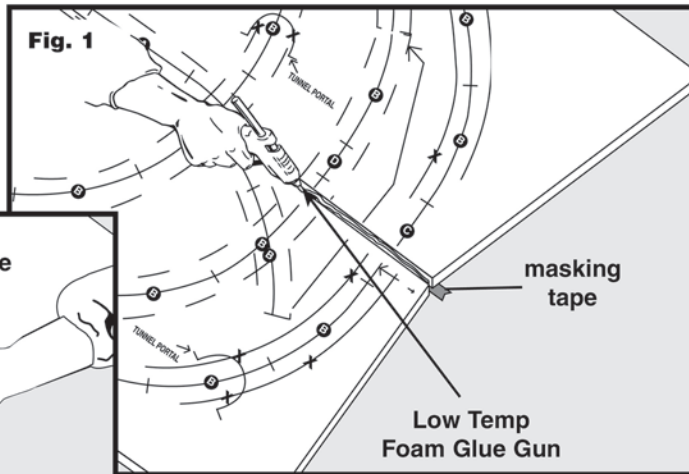

## Items Needed

- 4 - 2' x 4' Printed Foam Base Panels
- Foam Tack Glue or Low Temp Foam Glue Gun & Low Temp Foam Glue Sticks
- Foam Nails
- masking tape
- large piece of cardboard
- track

## Assemble Base Panels

- A track plan is printed on the four base panels. Lay them in the correct formation, then turn them upside-down.
- Use masking tape on the backside to temporarily connect them (**Fig. 1a**), then flip them right-side-up.
- Open up the seam and quickly apply the glue. This is easiest to do by slightly tilting the sheets away from each other, like opening a hinge (**Fig. 1**).
- Close seams and pin together with Foam Nails (**Fig. 2**), wiping off excess glue.

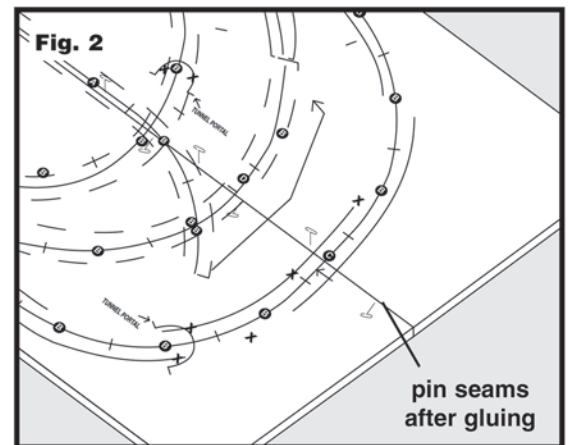

## Test Fit Track

- Assemble track according to the track plan printed on base (**Fig. 3**). Check to make sure you have all the pieces of track and that they fit on the track plan. Use small strips of masking tape to hold track segments together and to identify ends for easy reassembly.
- Remove track segments in large sections and store.

**TIP!** Store sections of assembled track on top of a large sheet of cardboard (approx. 2' x 3') to make them easier to move. We recommend marking each end of the track segments for easy reassembly (**Fig. 3a**).

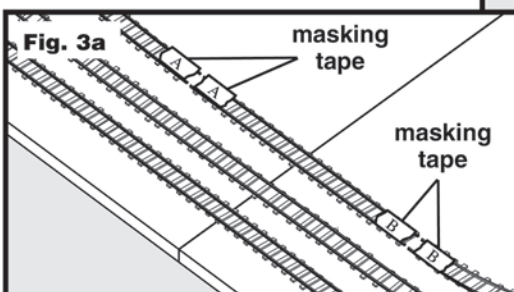
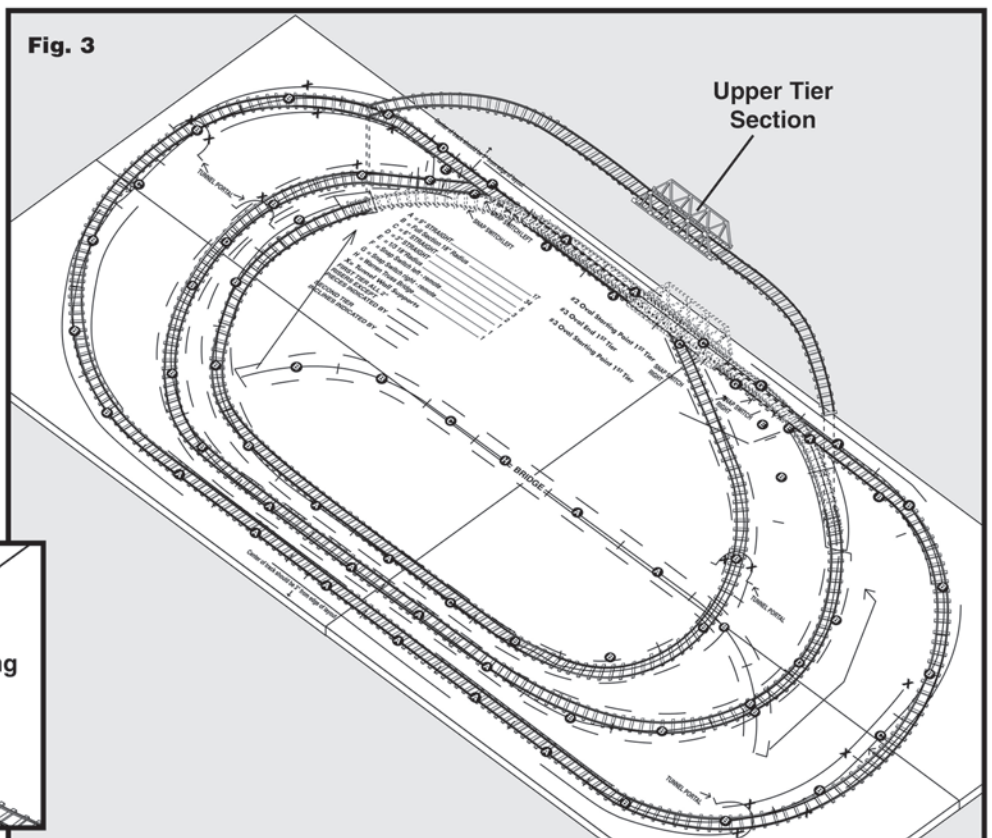

# Install Risers and Inclines/Declines

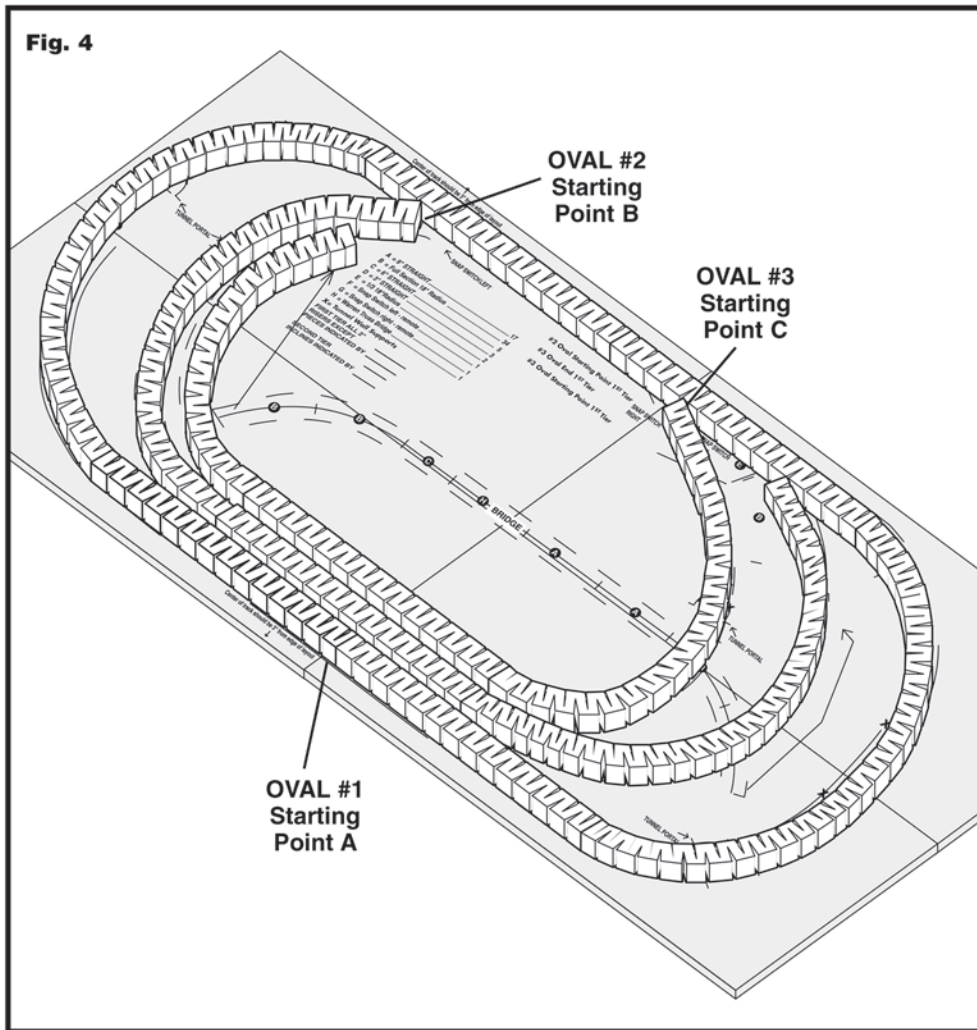

## Items Needed

- Foam Nails
- Foam Tack Glue or Low Temp Foam Glue Gun & Low Temp Foam Glue Sticks
- 3 3/4" – 4" Incline/Decline
- 3" – 3 3/4" Incline/Decline
- 2 1/4" – 3" Incline/Decline
- 1 1/2" – 2 1/4" Incline/Decline
- 3/4" – 1 1/2" Incline/Decline
- 0" – 3/4" Incline/Decline
- 2" Risers
- hobby knife
- straightedge or ruler
- 120-grit sandpaper

## Install First Tier Risers

Position 2" Risers, centered over printed track plan. Pin all pieces in place with Foam Nails.

- A. Begin placing 2" Risers at OVAL #1 Starting Point A (**Fig. 4**). Pin in place as you go, then glue (**Fig. 6**).
- B. Continue placing the 2" Risers beginning at OVAL #2 Starting Point B until you reach OVAL #3 Starting Point C. Pin in place as you go, then glue.
- C. Trim to length, if necessary (**Fig. 5**).
- D. Cut foam pieces from 1/4" Foam Sheet to fit the two small triangular areas where Risers converge as indicated (**Fig. 7**). Glue in place.

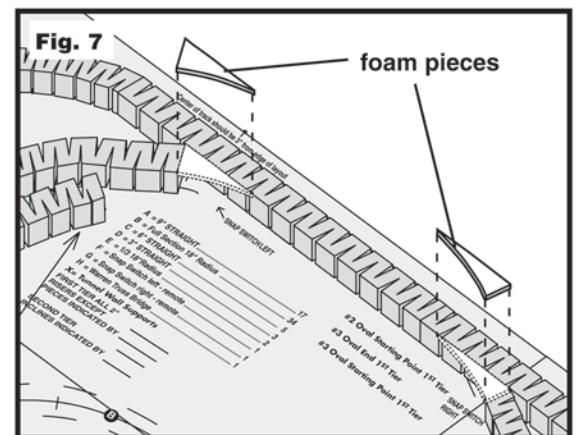
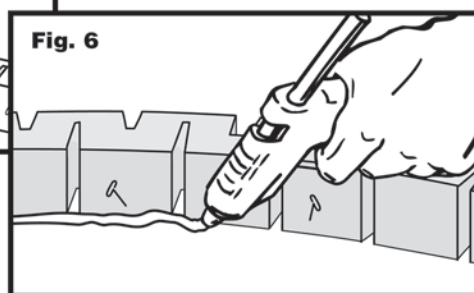
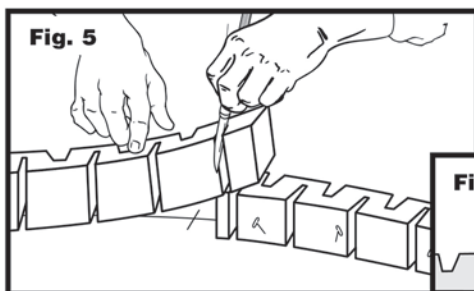

## Install Second Tier Inclines/Declines

- Measuring from the low end of the  $3\frac{3}{4}$ " -  $4\frac{1}{2}$ " Incline/Decline, mark an 8" length and cut. The high end of this 8" piece should be 4" (**Fig. 8**). Repeat on the other  $3\frac{3}{4}$ " -  $4\frac{1}{2}$ " Incline/Decline. Place and pin one of the 8" Incline/Decline pieces at OVAL #2 Starting Point D and the other at OVAL #3 Starting Point E. The 4" end should be placed even with the end of the 2" Riser (**Fig. 9**).
- Place and pin the  $3\frac{3}{4}$ " end of a  $3$ " -  $3\frac{3}{4}$ " Incline/Decline at the end of the  $3\frac{3}{4}$ " end of the 8" Incline/Decline directly behind Point D.
- Working clockwise and in descending order, place and pin the tall ends of each Incline/Decline starting with the  $2\frac{1}{4}$ " -  $3$ " Incline/Decline, followed by  $1\frac{1}{2}$ " -  $2\frac{1}{4}$ " Incline/Decline,  $\frac{3}{4}$ " -  $1\frac{1}{2}$ " Incline/Decline, and ending with a  $0$ " -  $\frac{3}{4}$ " Incline/Decline (**Fig. 10**).
- Place and pin the  $3\frac{3}{4}$ " end of a  $3$ " -  $3\frac{3}{4}$ " Incline/Decline at the  $3\frac{3}{4}$ " end of the 8" Incline/Decline directly behind Point E.
- Working counter-clockwise and in descending order, place and pin the tall ends of each Incline/Decline starting with a  $2$ " -  $3$ " Incline/Decline, followed by a  $1$ " -  $2$ " Incline/Decline, and ending with a  $0$ " -  $1$ " Incline/Decline (**Fig. 11**).
- Glue and let dry. Remove Foam Nails.

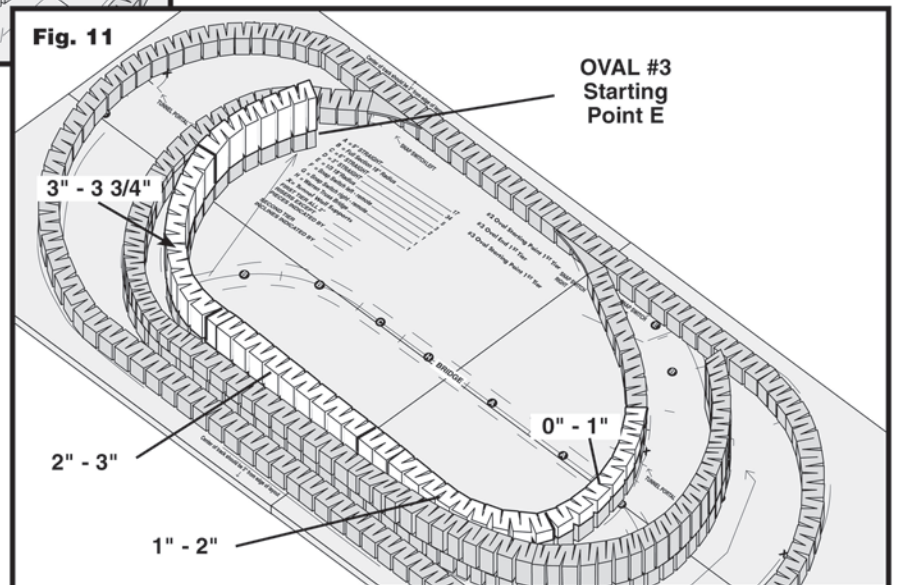
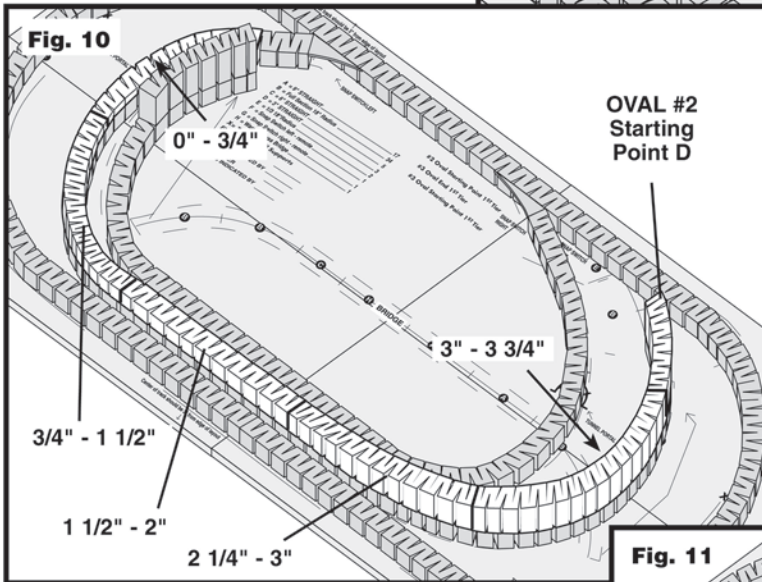
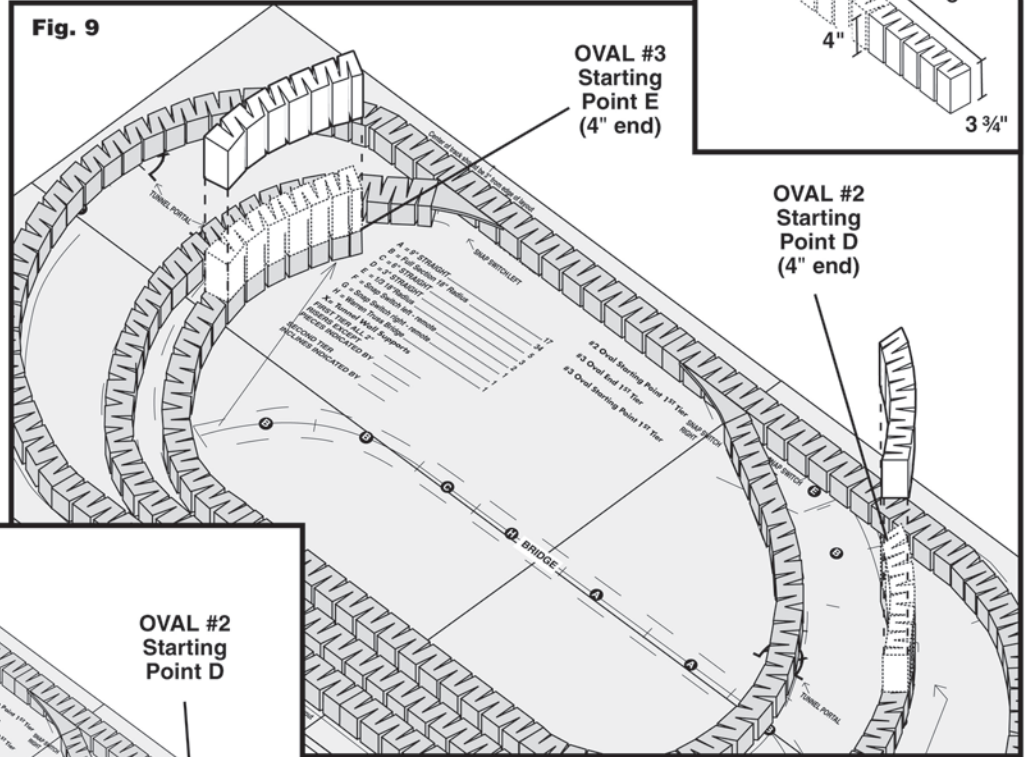
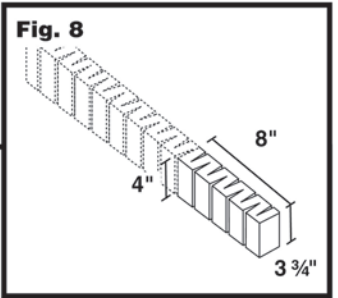

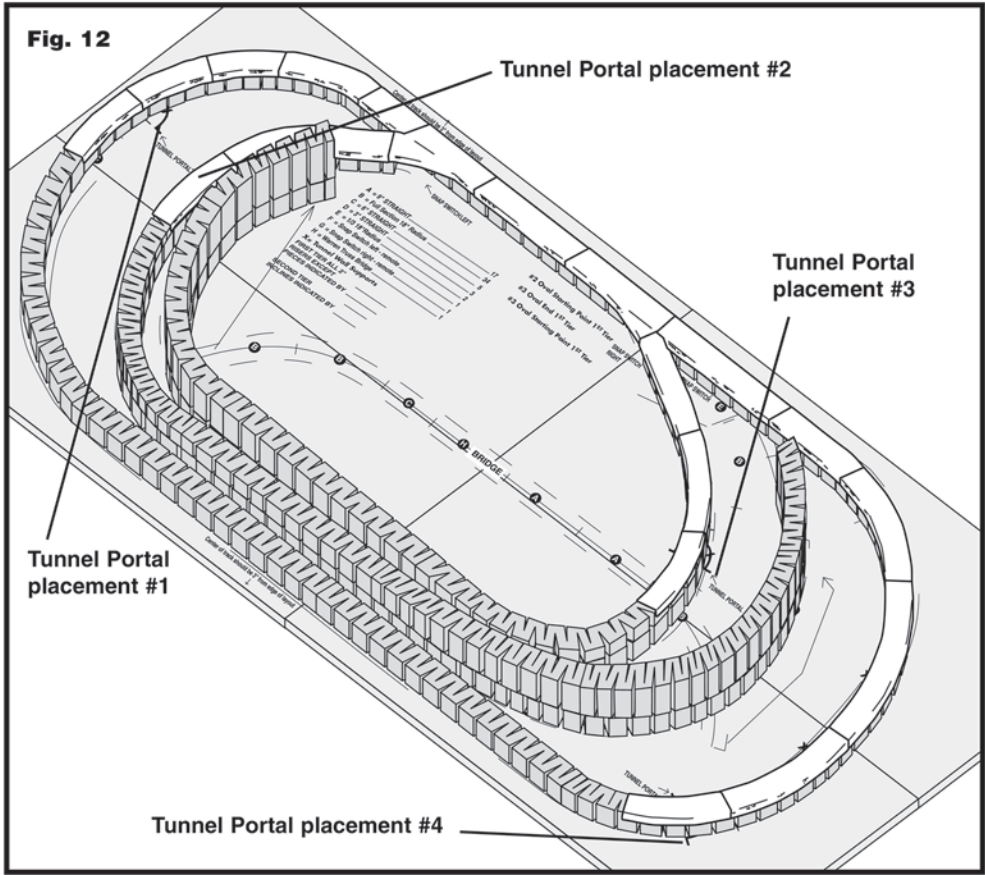

- Items Needed**
- Several 4" x 8" pieces of Plaster Cloth
  - Foam Tack Glue or Low Temp Foam Glue Gun & Low Temp Foam Glue Sticks
  - Foam Pencil
  - Scenic Sprayer
  - Black Construction Paper
  - 120-grit sandpaper
  - paint tray of water
  - liquid detergent
  - hobby knife
  - straightedge or ruler
  - small paintbrush
  - eyedropper or straw

## Plaster Cloth Inside Tunnel Areas

Cut several 4" x 8" pieces of Plaster Cloth.

- Holding Plaster Cloth pieces by corners, dip Plaster Cloth in water (Fig. 13) and place on Riser, bumpy-side-up (Fig. 14). Lay Plaster Cloth 8" outside the entrance of Tunnel Portal placement #1 (Fig. 12). Work clockwise until approximately 8" past Tunnel Portal placement #4. Overlap ends of pieces. Lay Plaster Cloth 8" outside the entrance of Tunnel Portal placement #2 until it meets the Plaster Clothed area. Continue clockwise 8" past Tunnel Portal placement #3 (Fig. 12).
- Plaster Cloth overlaps Riser sides by 1/2" – 1" (Fig. 14). Smooth out wrinkles by rubbing Plaster Cloth with fingers (Fig. 15). Let Plaster Cloth dry.

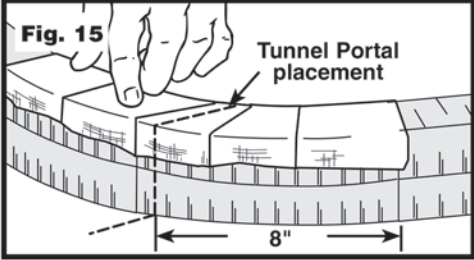
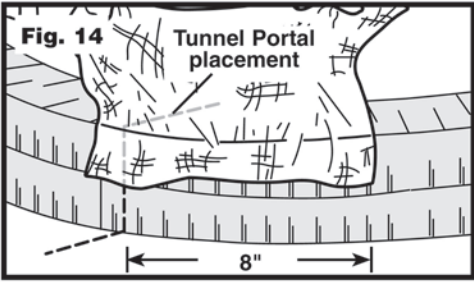
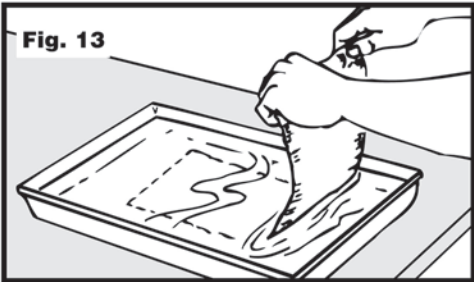

## Test Fit Track and Lay Track-Bed Inside Tunnel Areas

- Cut a 1/2" Foam Sheet into three - 4" wide x 24" long sections (Fig. 16). These sections will be used for permanent construction later.
- To make the temporary upper tier support, pin the #1, #2, #3, #4, #5 and #12 Profile Boards in place temporarily. Fit two of the 1/2" x 4" x 24" track supports (which you cut in Step A) lengthwise into the sixth groove (Fig. 18a) of the two temporarily placed Profile Boards #2 and #3. Use Profile Board Connectors to temporarily hold the upper tier track area as illustrated. (Fig. 18) Pin in place.
- Place entire track on layout, adjust for correct fit and placement, and pin with Foam Nails.
- Carefully trace around track on Plaster Cloth with Foam Pencil. Mark bridge location on Profile Boards for later reference (Fig. 18).
- Remove upper tier track and temporary supports. Remove all track inside tunnel areas in several large sections, including the first piece of track that extends beyond the Tunnel Portal placement areas #1, #2, #3 and #4 (Fig. 12).

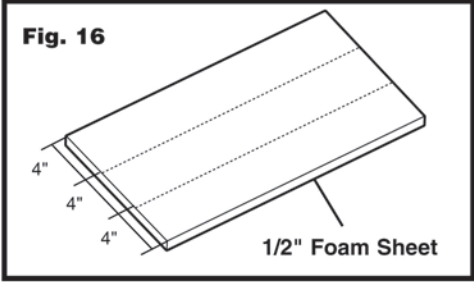



- F. Spread Foam Tack Glue over track area, inside tunnels or on bottom of the Track-Bed (**Fig. 17**).
- G. Lay Track-Bed inside Tunnel areas, keeping it centered on traced lines. Pin with Foam Nails (**Fig. 17**).
- H. 6" of Track-Bed should protrude out from all Tunnel Portal placements.
- I. Trim excess. Cut Track-Bed to form areas for turnouts (**Fig. 19**).
- J. Let glue dry and remove Foam Nails.

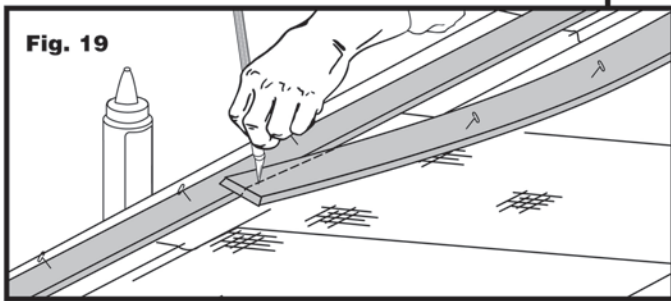
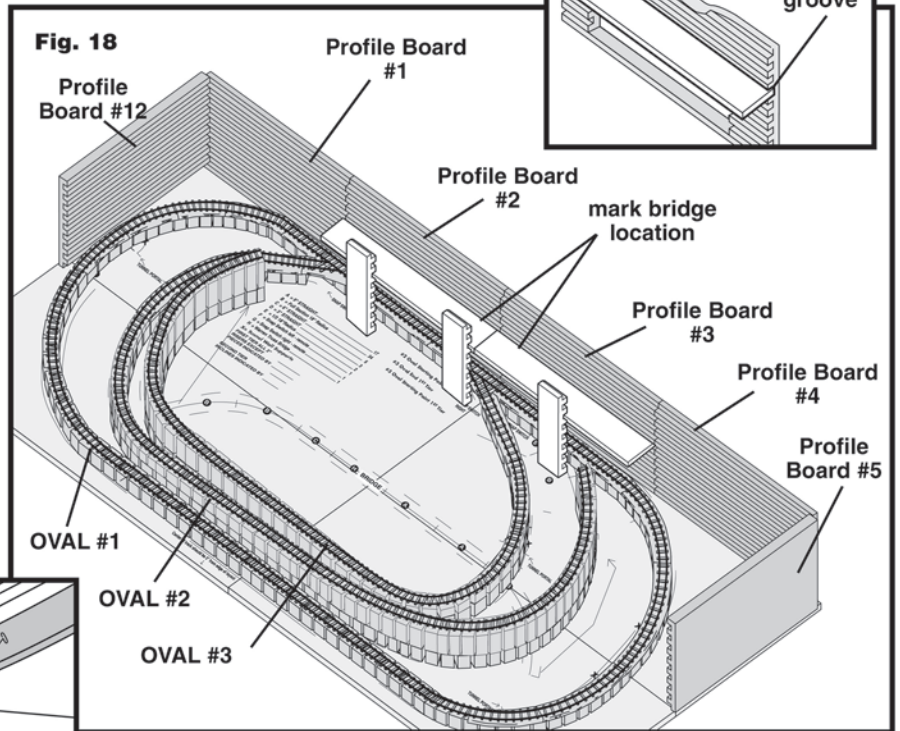
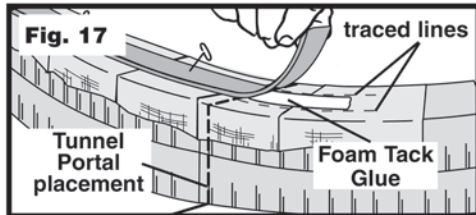

### Place Track and Ballast Inside Tunnel Areas

- A. Spread an even layer of Foam Tack Glue on top of Track-Bed, working in small sections (**Fig. 20**). **NOTE:** Do not put glue under any part of the track that has moving parts (**Fig. 61a**, page 18).
- B. Re-pin each track piece to the glue-covered Track-Bed, making sure there is a secure connection between track pieces. Allow glue to dry.
- C. Make a solution of "wet water" by mixing 2 drops of liquid detergent in one cup of water. This solution keeps the Ballast from clumping when applying Scenic Cement.
- D. Cover only 3" – 6" of the track inside the tunnel areas with Ballast. To do that, brush Scenic Cement on the sides of the Track-Bed. Be careful not to get Scenic Cement on the track. Pour Ballast directly over the track and ties. Be sure no Track-Bed shows through on either side.
- E. Brush excess Ballast from the ties and rails and spread evenly with a small, dry paintbrush (**Fig. 21**).
- F. Make sure Ballast is even with the ties for a realistic appearance.
- G. Lightly mist "wet water" with Scenic Sprayer on Ballast to prevent clumping.
- H. Use an eyedropper to carefully apply Scenic Cement on Ballast (**Fig. 22**). If necessary, clean rails with Tidy Track Rail Pal (TT4575).

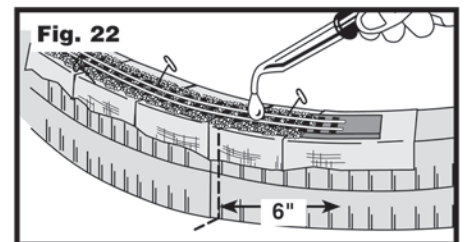
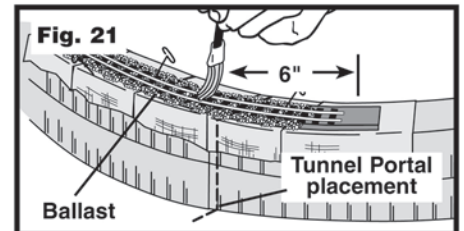
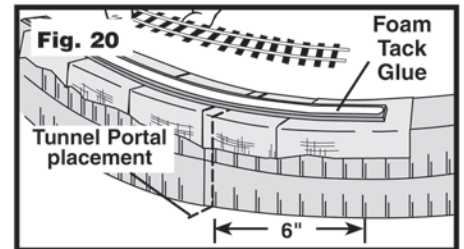

### Place Foam Tunnel Portals

Trace outline of four Tunnel Portals onto 1/2" Foam Sheet (**Fig. 23**). Cut out with hobby knife. Foam Tunnel Portals serve as reference for tunnel placement and provide stable backing for Tunnel Portals. Cut scrap pieces of foam the height of the Riser and/or Incline/Decline for Tunnel Portal supports. Locate Tunnel Portal positions on track plan and pin foam Tunnel Portals in place with Foam Nails (**Fig. 24**).

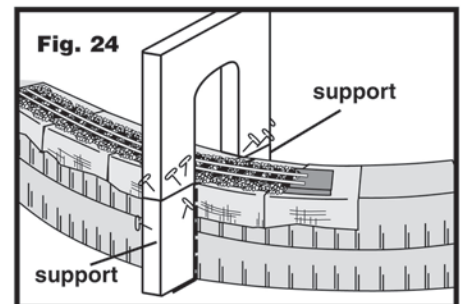
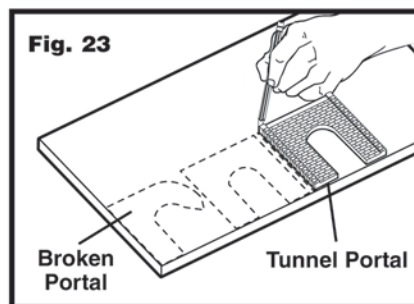

## Tunnel Walls

Tunnel walls will be cut from 1/4" x 12" x 24" Foam Sheets to specified dimensions (**Fig. 25 and Fig. 26**). Place walls along Plaster Clothed areas to form tunnel walls (**Fig. 29**). Cut 14 - 1" x 1" high supports (from 1/2" foam) for tunnel walls and glue onto base in areas shown. Tops of tunnel walls should be even with tops of foam Tunnel Portals (**Fig. 27**). When installing foam portals vertically, small gaps may occur. On Walls #8, #9 and #11, one end of the sheet will rest on a support and the other end will angle down and rest on the base (**Fig. 28**). Some walls have no support and will sit on the base next to the Riser. Trim pieces if necessary. **TIP! Gently flex the 6" x 24" tunnel wall pieces back and forth so they will not break when following the contours of the Risers. Paint 6" to 8" inside all tunnel entrances before the tunnel roofs are installed. Use the black tunnel paint included.** To darken the tunnel behind the custom foam tunnel portal on OVAL #2, glue black construction paper, included, on the area to cover the Riser and Incline/Decline.

Test fit tunnel walls by pinning them in place with Foam Nails. Allow for train clearance. When satisfied with fit, glue tunnel walls and foam Tunnel Portals in place. When dry, remove Foam Nails.

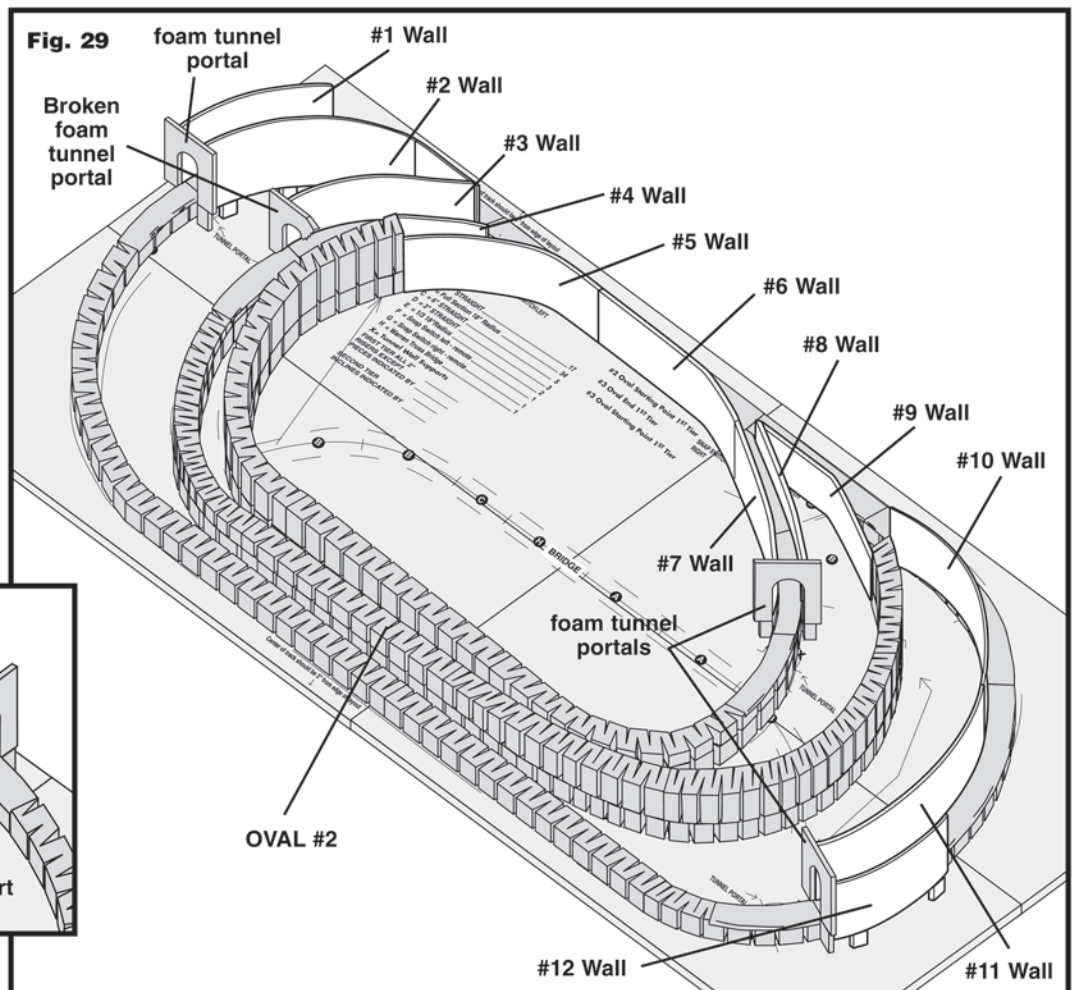
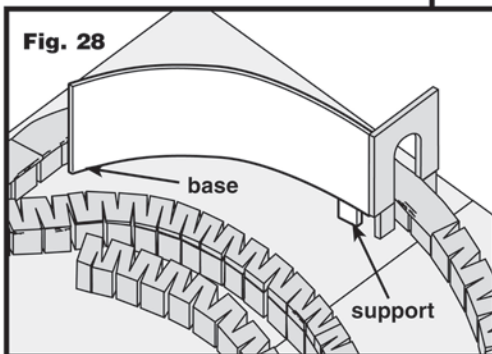
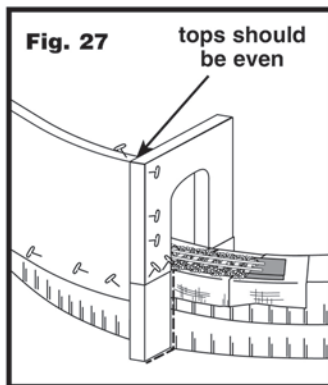
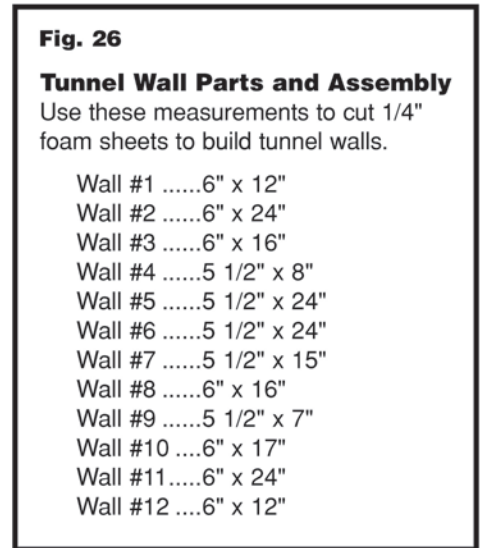
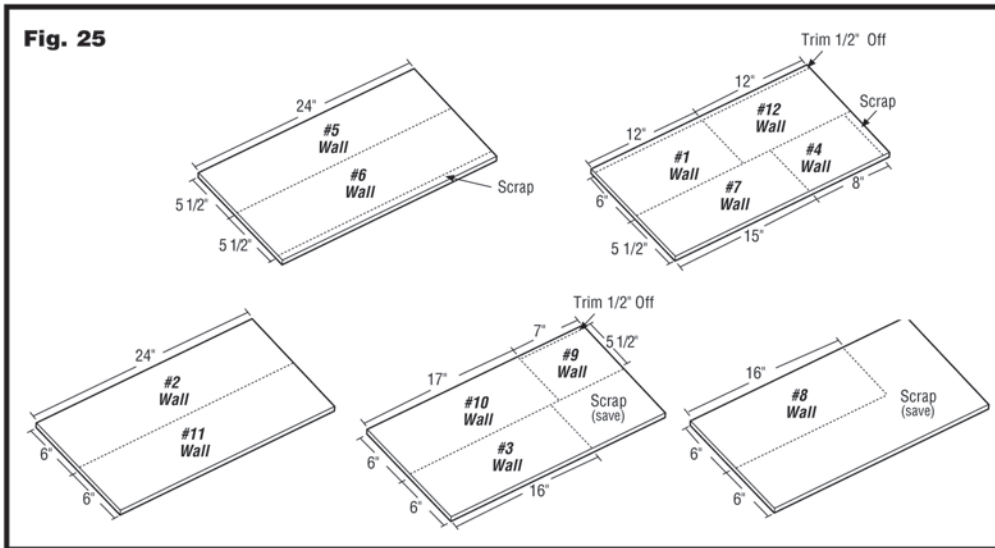

Profile Boards are ribbed 8" x 24" interlocking components with a 1" edge on one side and a 1/2" edge on the other. Front and back Profile Boards will be assembled with the 1" edge down (ribs inward), and left and right Profile Boards will be assembled with the 1/2" edge down (ribs inward) so they will interlock at corners (**Fig 30**). Connectors interlock Profile Boards side-by-side and on top of each other (**Fig. 30a**).

## Items Needed

- 11 Profile Boards
- 5 Connectors
- Foam Nails
- Foam Knife or hobby knife
- Foam Pencil
- Hot Wire Foam Cutter
- straightedge or ruler
- scissors

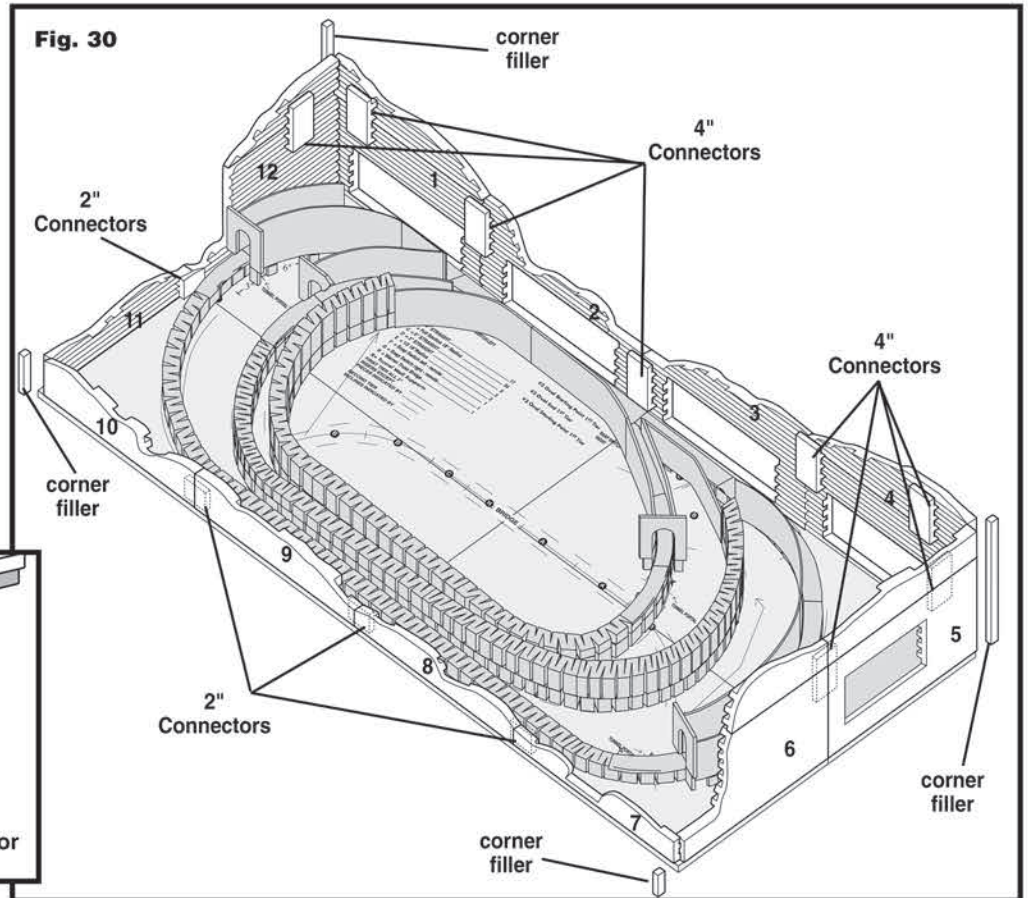
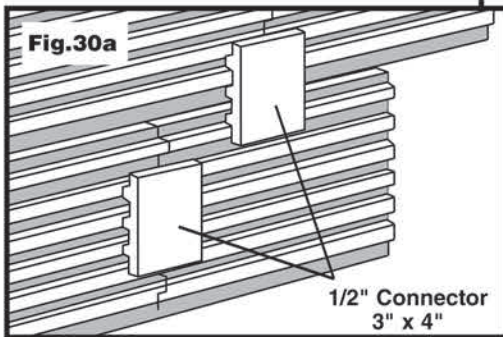

## Cut Access Panels

- Cut the access panel openings on Profile Boards #1, #2, #3, #4 and #5 using a hobby knife and a straightedge (**Fig. 31**).
- Cut a 1" x 1" hole in the center of each access panel for easy removal (**Fig. 32**).

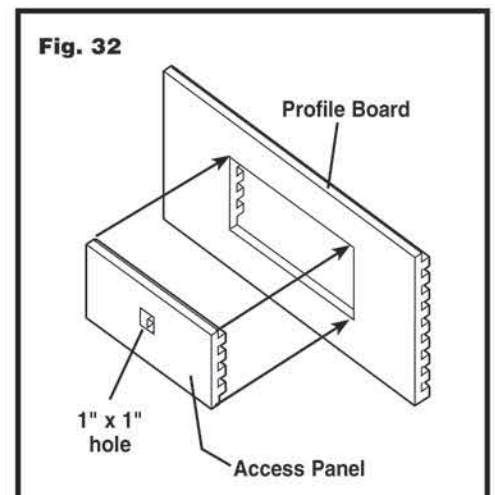
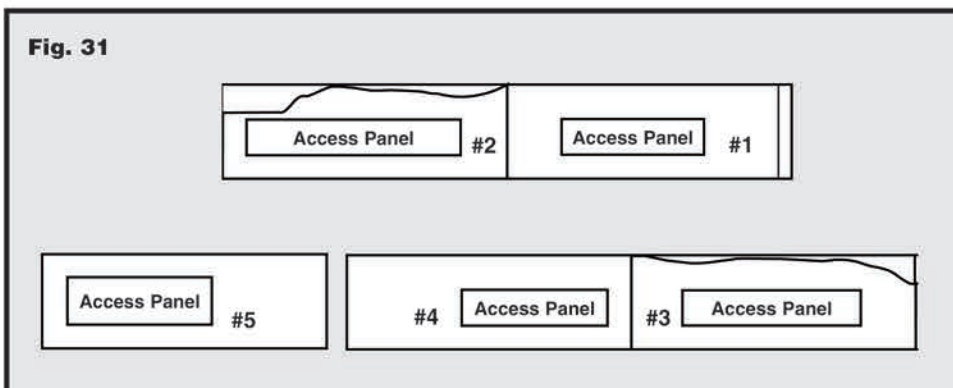

## Cut and Assemble Profile Boards

A. There are 11 printed Profile Boards. Use Woodland Scenics Hot Wire Foam Cutter to cut terrain contours following printed patterns (**Fig. 33**).

B. Locate the five 3" x 8" Connectors and cut (**Fig. 34**).

C. Sort the Profile Boards and Connectors by all four sides and cut following patterns.

**Front View** – 4 cut Profile Board pieces #7, #8, #9, #10 and three 2" Connectors.

**Left View** – 3 cut Profile Board pieces #11, #12, #12a, one 2" Connector and one 4" Connector.

**Back View** – 6 cut Profile Board pieces #1, #1a, #2, #3, #4, #4a and five 4" Connectors.

**Right View** – 4 cut Profile Board pieces #5, #5a, #6, #6a and two 4" Connectors.

D. Starting with front of layout, assemble Front Profile Boards with Connectors (**Fig. 30, page 11**). The ends of each side assembly are 1/2" from corners of base and interlock with the Profile Board of the adjoining side. **NOTE:** The 1/2" is critical for alignment of all sides with the base (**Fig. 33a**). Trim, if necessary.

E. Align smooth sides of Profile Boards with outside edge of base and pin them in place with Foam Nails.

F. Assemble the remaining three sides in the same manner.

G. When all Profile Boards are in place, apply glue to the base on inside of the layout, to the Connectors and at the seams.

H. Now is a good time to touch up terrain contours to make them continuous and trim any Connectors that extend above the layout sides (**Fig. 35**).

I. Cut six 1" x 2" scraps of Profile Board and glue two each to the inside of access panel opening of Profile Boards inside layout (**Fig. 36 and Fig. 37**). These will act as stops for the access panels.

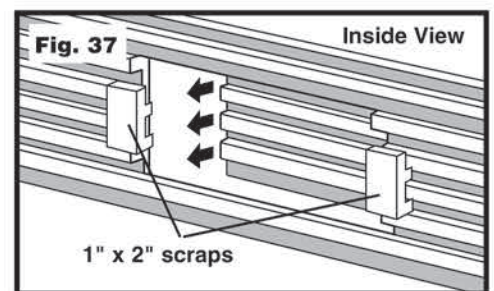
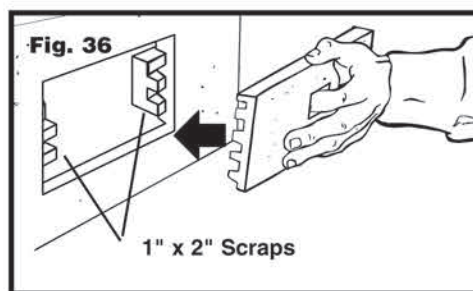
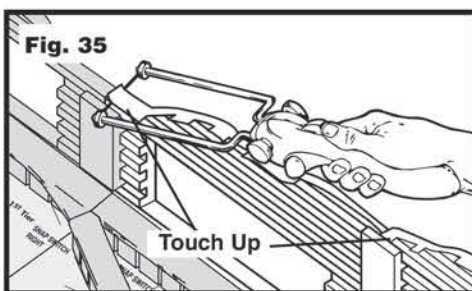
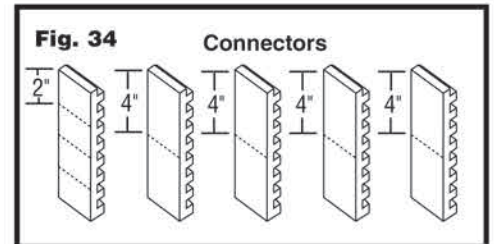
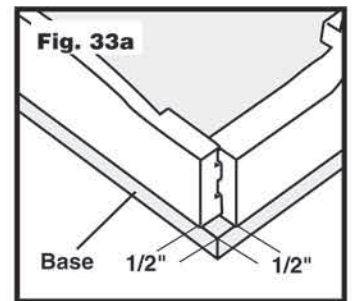
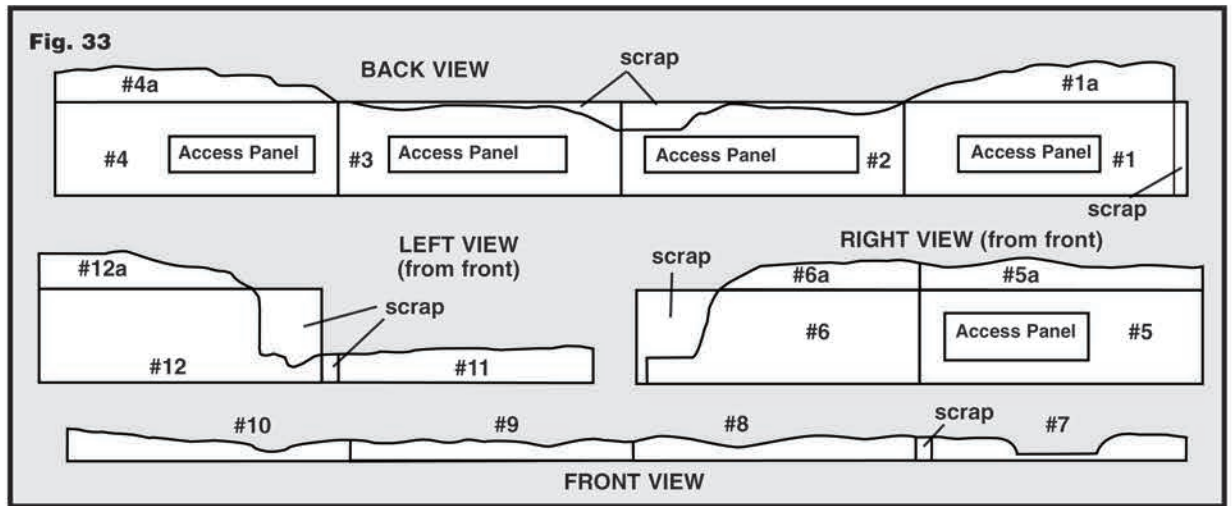

## Fill Corner Joints

Use Profile Boards to cut 1/2" x 1/2" scraps (**Fig. 38**). Fill the void at each corner where Profile Boards meet. Trim to height of corner (**Fig. 30**).

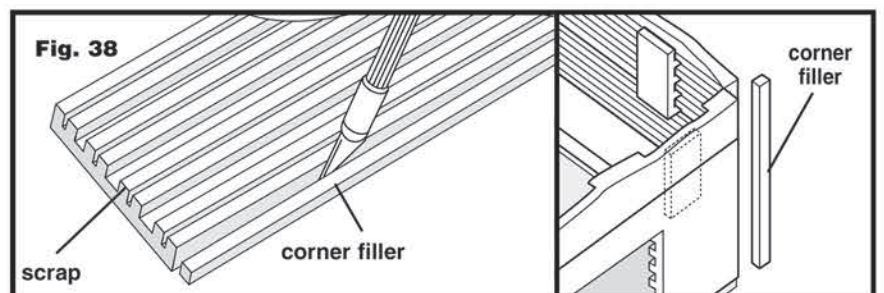

# Upper Tier Track Supports

- Cut a 1/2" x 1/2" Notch in the ends of each upper tier Incline/Decline (**Fig. 39**).
- Now using the three pieces you cut from the 1/2" Foam Sheet (**Fig. 16, page 8**), cut two of them down, one to 18" and one to 22" (**Fig. 40**).
- Place 18" Track Supports and 22" Track Supports over the back tunnel area lengthwise into the sixth groove (counting from the bottom) of Profile Board 2 and 3, leaving space for the 8" River Gap (**Fig. 41**) beneath the bridge. Reference where you marked for bridge location (**Fig. 18, page 9**).

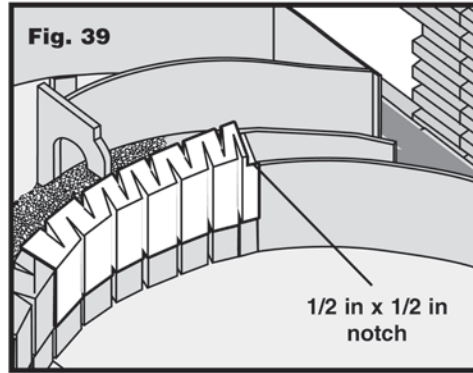

## Items Needed

- Foam Nails
- Foam Pencil
- Foam Tack Glue or Low Temp Foam Glue Gun & Low Temp Foam Glue Sticks
- 1/2" Foam Sheets
- hobby knife

**Fig. 40**

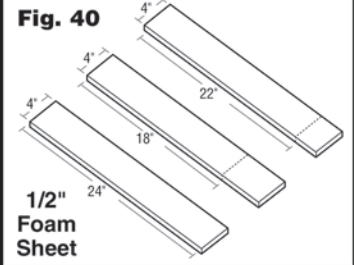

- NOTE:** You may need to cut a notch to fit the Foam Sheet around the Profile Board Connectors (**Fig. 41**).
- Replace the entire track and pin in place. Make sure the 8" River Gap is properly placed. The bridge should overlap 1/2" on both upper tier track supports. Adjust if necessary. Use Foam Pencil to outline track on upper tier track supports (**Fig. 43**). Then remove the upper tier track.
  - Cut a 5" x 8" piece of foam from a 1/4" Foam Sheet and fit into place for the river bottom. Foam Sheet will rest on first rib of Profile Board and tunnel wall (**Fig. 42**). Adjust the foam piece to fit in place. Foam Sheet should fit 1/4" below upper tier supports.
  - Cut the 4" x 24" Foam Sheet into two pieces to bridge the gap between the upper tier Incline/Decline and upper tier track supports (**Fig. 41**). Make sure these pieces fit flush into the 1/2" x 1/2" notch cut on the upper tier Incline/Decline (**Fig. 39**). This entire area should be level and flat.

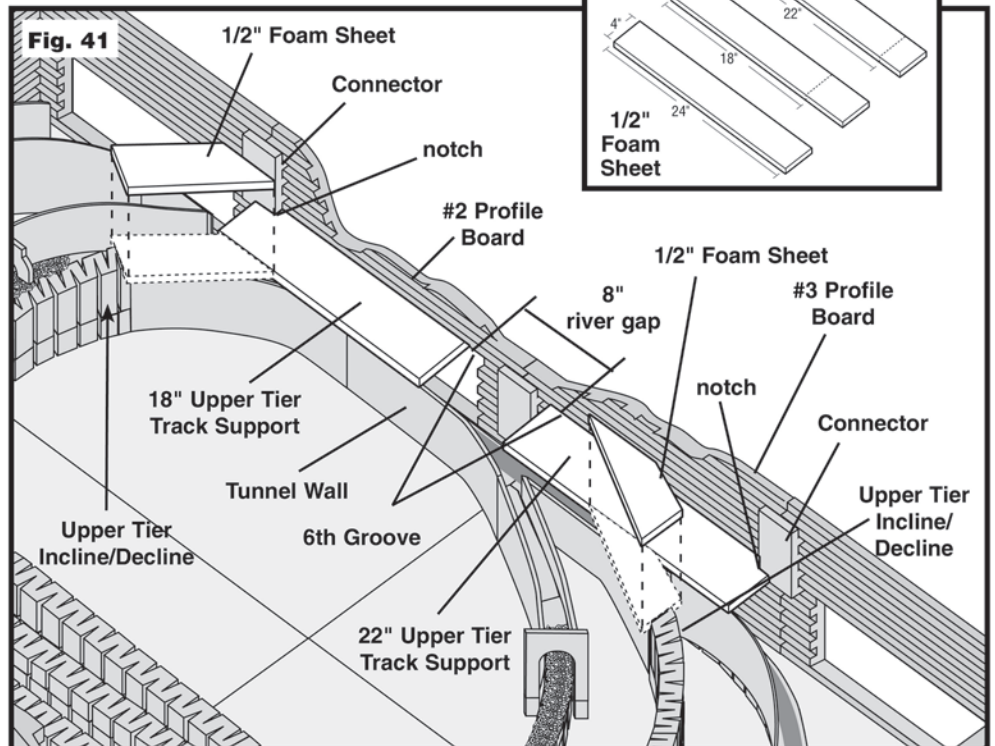

- Install 0" – 1" Inclines/Declines, on both sides of the river gap, with the 1" end of the Incline/Decline even with the river gap (**Fig. 44**). Center over the track tracings.
- Re-install the track, test fit and pin track. It is recommended that you run your train on the track to test for proper clearances. If all foam work was installed correctly, the train should not touch any tunnel walls or overpass areas. Make adjustments if necessary.
- If no clearance problems are found, remove the loose track. Then install and glue upper tier track supports, river bottom and the two 0" – 1" Inclines/Declines into place.

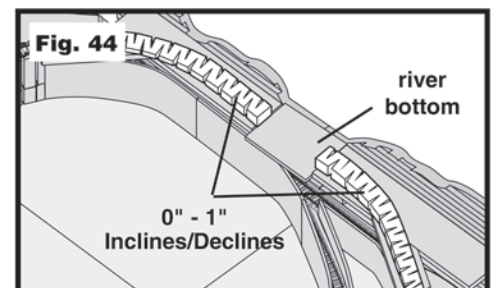
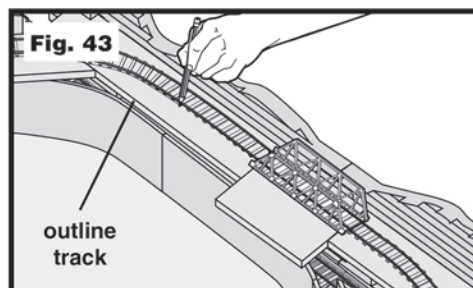
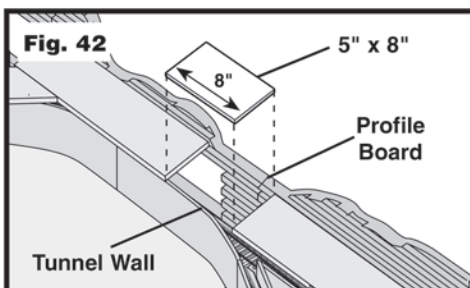

# Tunnel Roof and Platforms

The tunnel roof serves as support for paper wads used in a future step.

- Test fit 1/4" Foam Sheet and place inside the corner of the layout with edges in between ribs of back Profile Board (Fig. 45).
- With Foam Pencil, mark Connector locations and cut 1" notches in Foam Sheet to fit around them.
- Set aside one 1/4" Foam Sheet for river bottom.
- Pin Foam Sheet down and trim to meet outside edge of tunnels. Continue covering all tunnel areas in this manner with 1/4" Foam Sheets (Fig. 46). Don't worry about neatness, the work will be covered in a later step.

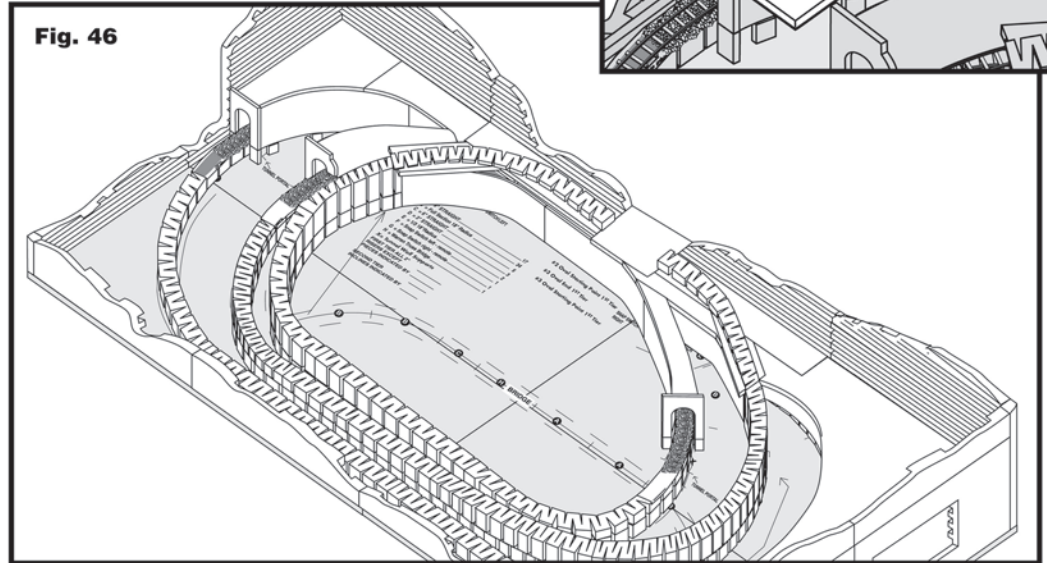
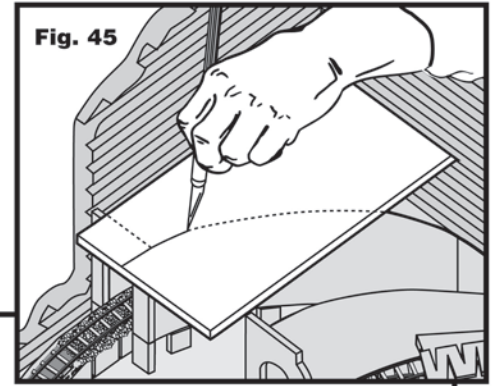

- Items Needed**
- Foam Nails
  - Foam Tack Glue or Low Temp Foam Glue Gun & Low Temp Foam Glue Sticks
  - Foam Sheets
  - hobby knife
  - masking tape
  - awl or small drill bit
  - newspaper

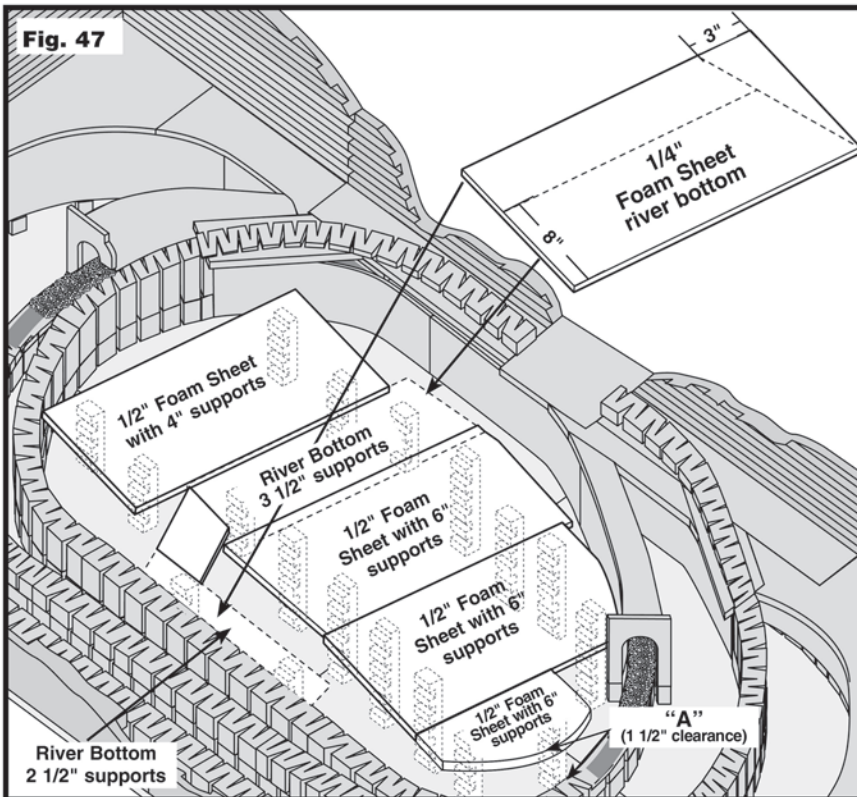

## Cut Foam Sheets to Create Flat Areas

Foam Sheets make level areas to place buildings, factories, towns and roads. Because there are no precise measurements for flat areas on the layout, refer to illustrations to decide placement and approximate size of areas.

- Cut a 1/4" Foam Sheet for River Bottom. Use 1/2" Foam Sheets to make flat areas (Fig. 47).  
**NOTE:** A clearance of 1 1/2" is recommended between Foam Sheets and Inclines/Declines marked "A" (Fig. 47).
- Make supports from scrap Profile Boards to lift the flat areas off the base.
- When satisfied with flat areas, glue foam in place. Let dry.

## Test Fit Buildings

If you have purchased the River Pass Building Kits or have other buildings, test fit them in flat areas, keeping plenty of clearance for train and landscaping items. See back page (Fig. 65) for suggested placement.

Woodland Scenics makes it easy to add realistic dirt, gravel and paved roads to the layout. Use Risers to create the foundation for the roads (Fig. 48). Other road areas have a foam base for their foundation. Refer to back page (Fig. 65) for road placement ideas or create your own.

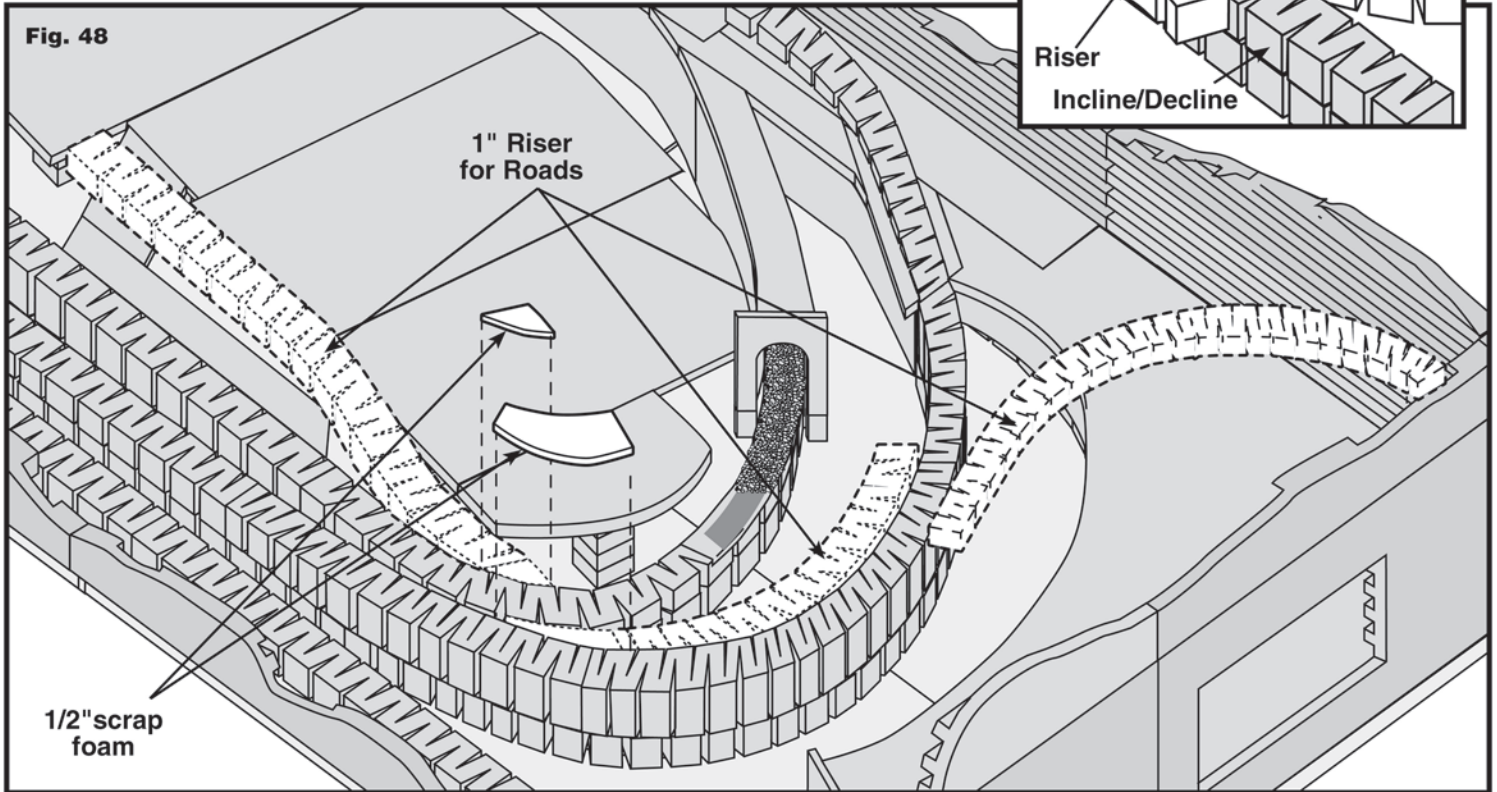

### Add Road Foundation

To build the road foundation, use three 1" Risers. Pin Risers in place, using scrap foam and newspaper wads to elevate the Riser to desired height (See "Add Plaster Cloth and Track-Bed" on pages 16 and 17 for instructions on how to make newspaper wads). At intersections of the railroad and roads, lift the Risers and scrap foam up 1/4" above Incline/Decline where crossing will be (Fig. 49). When satisfied, glue all scrap foam in place with the Low Temp Foam Glue Gun. Remove Foam Nails.

Position track on layout. Determine where your transformer will be located and run wiring through access panels or poke a hole through Profile Board at any convenient location.

### Method 1

Make a hole in the Risers just large enough for wire, or run wire down the sides and along Risers and Inclines/Declines. Tape or glue wire to base.

### Alternate Method

Drill a hole just large enough for the wire to pass through the base (an awl can be used to punch the hole). On the underside of layout, route wiring to power supply or electric switches. We recommend leaving a single exit point for wiring to maintain a clean appearance.

**NOTE:** When covering layout with Plaster Cloth, consider the position of the wiring.

## Add Plaster Cloth and Track-Bed

Before adding Plaster Cloth, remove track, make sure all foam components are glued in place and Foam Nails are removed. Stack, compress, shape and form the newspaper wads to conform to the desired contours for the mountains, hills, dry creek bed and other terrain features. Refer to photo on front of the box for these details. You will need several newspapers to create the terrain.

### Items Needed

- Foam Nails
- paint tray of water
- scissors
- hobby knife
- several newspapers
- masking tape

Fig. 50



### Make and Place Newspaper Wads

- Begin at the outside edge of a sheet of newspaper and roll the edges under to form pillow shapes as shown (Fig. 50).
- Stack wads even with or below the top of Profile Boards to form realistic contours (Fig. 51). Fill in between Risers and around perimeter of Foam Sheets.
- Use masking tape to hold newspaper wads in place (Fig. 52).
- Allow clearance around foam Tunnel Portals.

Fig. 52



Fig. 51

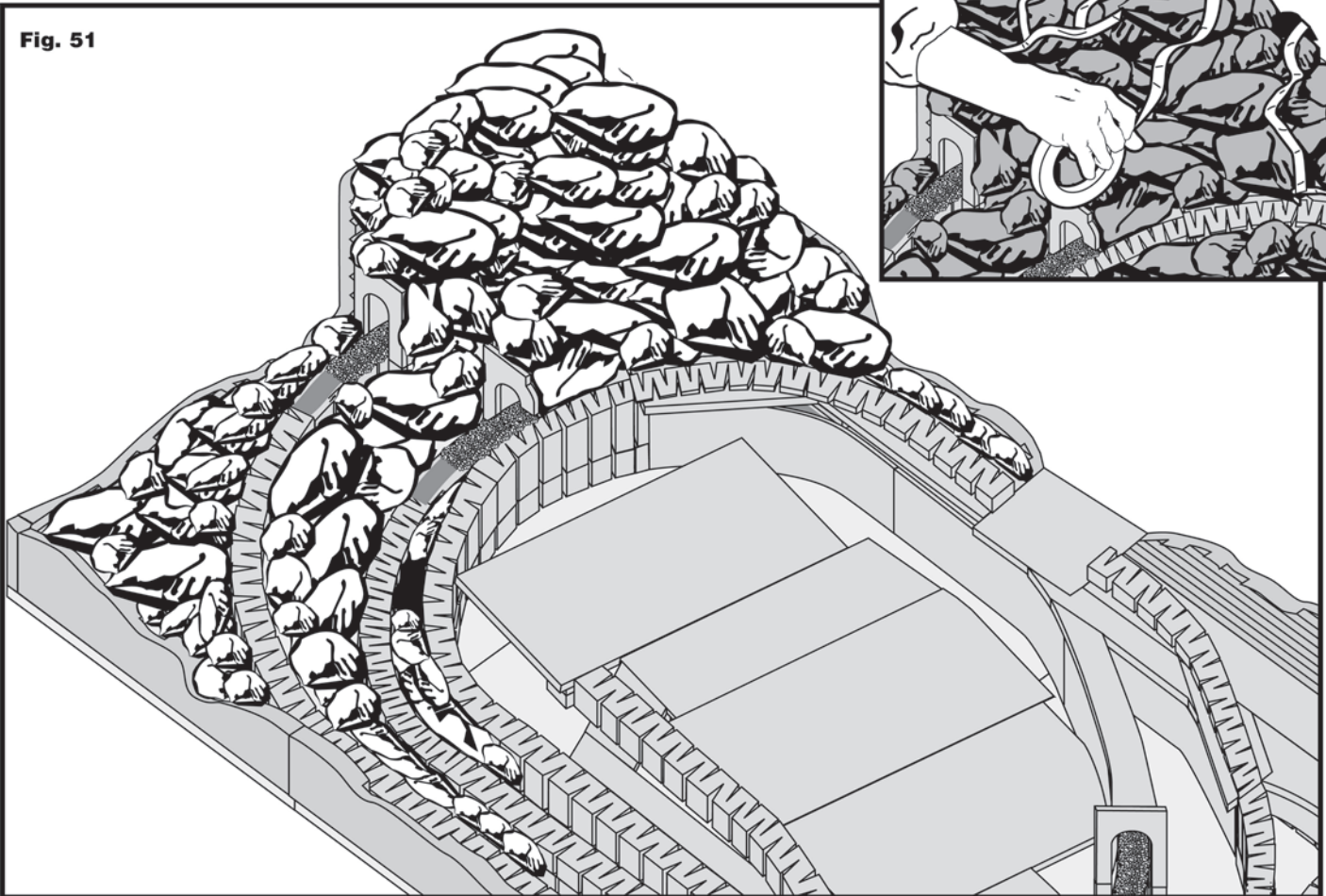



## Plaster Cloth

Plaster Cloth makes a strong, hard shell over the layout for the application of landscape and scenery products.

- A. Set aside one roll of Plaster Cloth for layout sides. Cut one roll into 12" pieces.
- B. Hold pieces by corners. Dip into pan of water (**Fig. 53**).
- C. First, place the 12" strips along all the Risers and Inclines/Declines, bumpy side up, letting the edges overlap onto adjoining foam or paper wads.  
**TIP!** See "Plaster Cloth Inside Tunnel Areas" instructions on page 8. Butt the ends without overlapping and smooth Plaster Cloth with fingers so there are no bumps, wrinkles, holes or folds to cause problems when laying track (**Fig. 54**).
- D. Next cover the rest of the layout beginning at the front left-hand corner of layout. Place a piece bumpy side up over wads, leaving a 1" strip overlapping edges of layout (**Fig. 55**).
- E. Fold overlapping edge over on itself to make it even with the edge of the layout (**Fig. 55**).
- F. Rub Plaster Cloth to smooth bumps and fill holes in cloth.
- G. Working from left to right, overlap 50% of the previous strip to form a double-thick plaster surface. Working from top to bottom, overlap 1" of the previous strip (**Fig. 56**).
- H. When covering the space between the tracks, it is still necessary to get a double thickness of Plaster Cloth on the paper wad areas for strength. On the large, flat areas where foam is the base, it can be doubled, but a single layer is sufficient.
- I. Let Plaster Cloth dry for 4–6 hours.

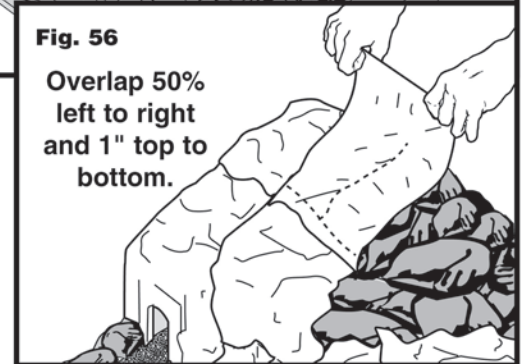
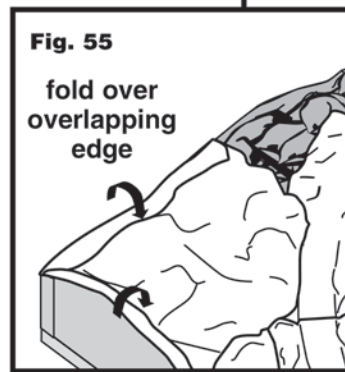
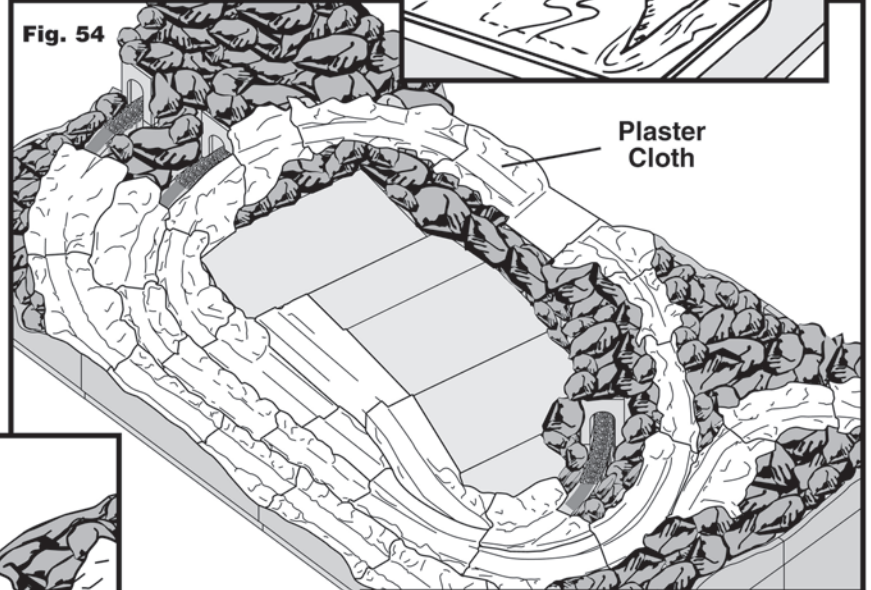
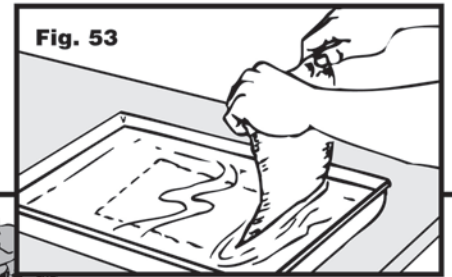

## Plaster Cloth Sides of Layout

Pin pieces of Plaster Cloth to all sides of layout, with bumpy side out. On the front and wherever possible use a continuous piece, allowing an inch or so to overlap the sides and top. Spray the Plaster Cloth thoroughly with water, working the plaster with your fingertips to fill in holes (**Fig. 57**). Apply around access panel areas, overlapping opening by 1/2" (**Fig. 58**). When Plaster Cloth is thoroughly dried, cut Plaster Cloth out of access panel opening with hobby knife.

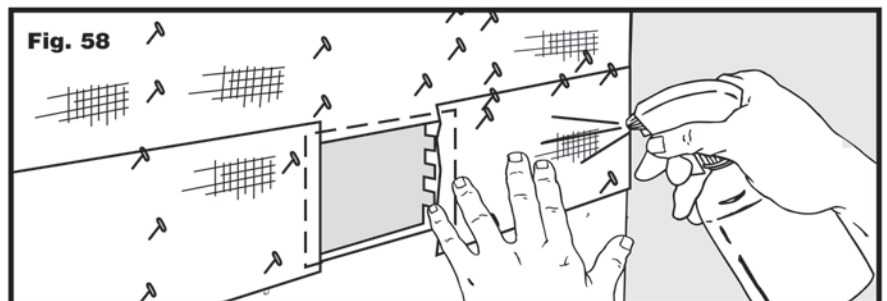
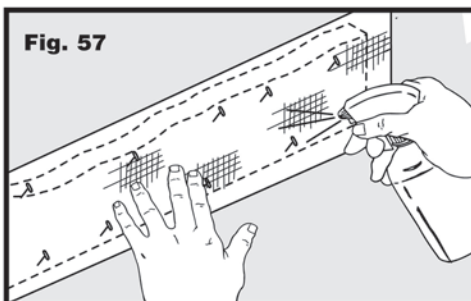

## Test Track

Once Plaster Cloth has dried, re-fit track on Risers. Hook up power and test train for clearance and derauling problems. When a clear run is made with the train, remove train, pin track in place and retrace pattern on Plaster Cloth covered Riser. Make sure to clearly mark the position of the track. Now, remove track in large sections as before. Use masking tape to secure track pieces if necessary.

## Lay Track-Bed

Glue down Track-Bed by spreading a layer of Foam Tack Glue on the bottom of the Track-Bed or on traced lines (Fig. 59). Make sure Track-Bed is centered on traced lines and pin in place. Make sure any butted ends of Track-Bed meet without bumps, ridges or gaps. To do this, overlap ends and cut through both pieces with a hobby knife (Fig. 60). Let glue dry and remove Foam Nails.

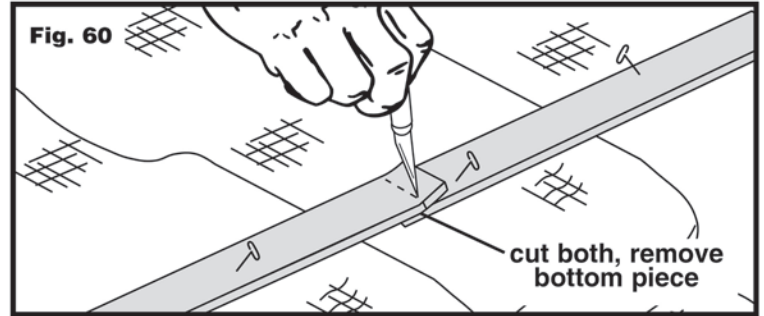
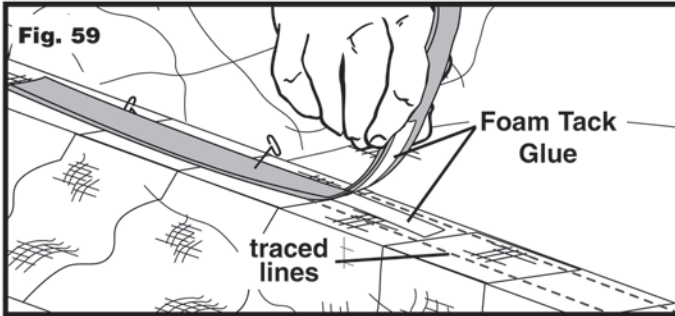

## Glue Down Track

Making sure all track connectors are snugly attached and the track is not crimped, begin laying track from the tunnel portals where the track is already in place. Glue remaining track to Track-Bed by spreading an even layer of Foam Tack Glue on top of Track-Bed and attaching track one section at a time (Fig. 61). Be careful not to use too much glue or get glue on rails. It is especially important to avoid putting any glue under any of the track's moving parts (Fig. 61a).

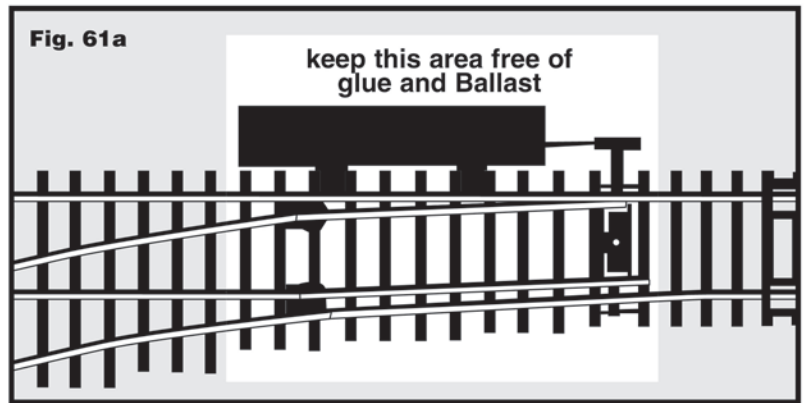
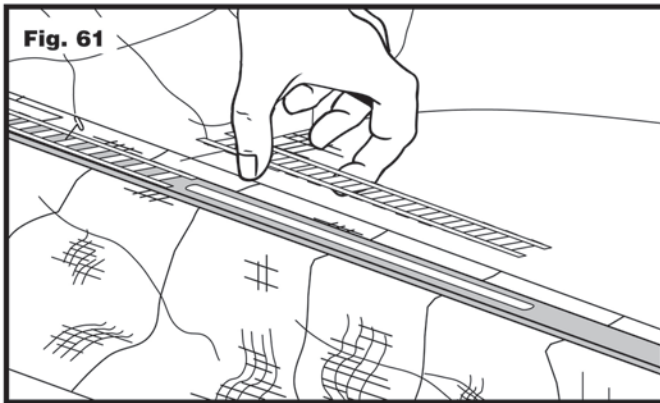

## Install Tunnel Portals and Culverts

### Install Tunnel Portals

Test fit Portals at each foam Tunnel Portal opening. Make sure to center Portal opening over the track. If Portal does not fit properly against the foam Tunnel Portal, cut into the Plaster Cloth with a hobby knife to make room for it (Fig. 62). Make sure there is enough clearance for the train to pass. When satisfied with test fit, spread Foam Tack Glue on back of Tunnel Portal and place onto foam tunnel portal. Fill in any gaps with small, wet strips of Plaster Cloth. Allow the glue to dry. Use only the left side of the 2-piece Broken Tunnel Portal as shown in Fig. 63. Discard the right side, or use elsewhere on layout as debris (Fig. 63). **NOTE:** You may want to paint Tunnel Portals before you install them. Paint is included in River Pass Scenery Kit #2 (S1488).

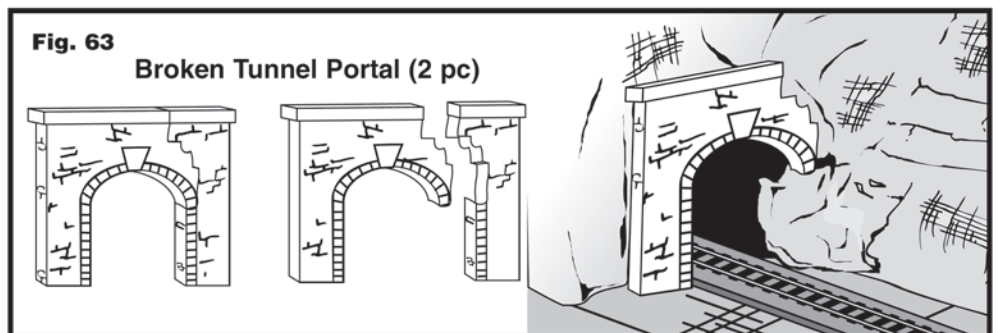
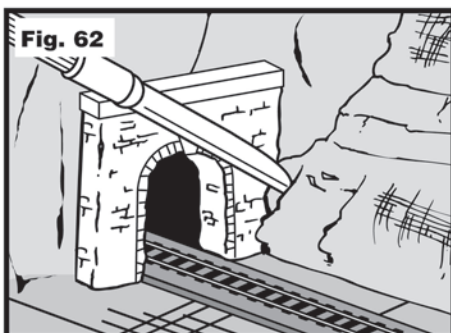

## Install Culverts

You need to assemble Culverts before attaching them to your layout. The Retaining Walls can be used in any formation with the Culvert, or not at all. Test fit Culverts on the layout (**Fig. 64**). You may need to cut into the layout to allow enough room for the Culvert. To attach, spread Foam Tack Glue on the back of the Culvert and in the Culvert area. Allow glue to become tacky and press into the terrain. Fill in any gaps with small, wet strips of Plaster Cloth. Allow the glue to dry.

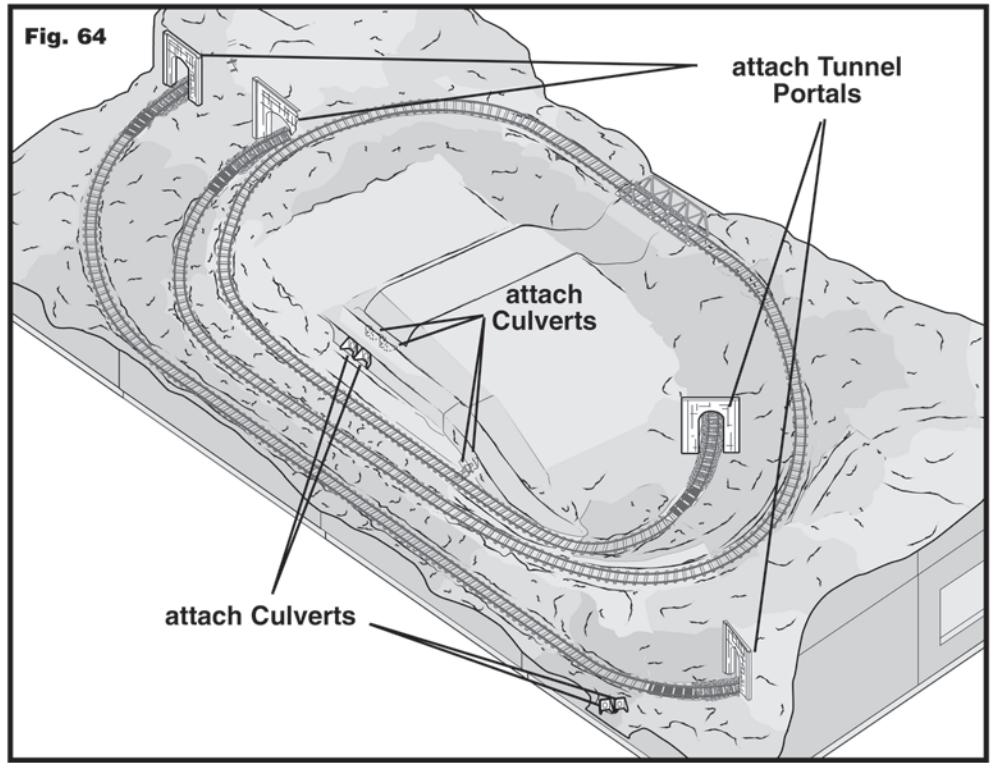

## Base Paint

Save the Base Paint included in this kit to paint your outside base once landscaping has been completed.

## Products

If you desire additional items, refer to the list below for the Woodland Scenics products that were used to construct River Pass Layout Kit.

Description	Item No.	Page	Description	Item No.	Page
<b>SUBTERRAIN ITEMS</b>			<b>LANDSCAPING SYSTEM ITEMS</b>		
2" Riser 4/pkg .....	ST1408	6	Low Temp Foam Glue Sticks .....	ST1446	3
4% Incline/Decline Set .....	ST1411	7	24' HO Scale Track-Bed Roll .....	ST1474	9
3% Incline/Decline Set .....	ST1416	7	<b>TERRAIN SYSTEM ITEMS</b>		
1/4" Foam Sheets.....	ST1422	6	Buff Fine Ballast .....	B73	9
8" Profile Boards and Connectors.....	ST1419	11	Buff Fine Ballast (Shaker) .....	B1373	9
1/2" Foam Sheets.....	ST1423	9	Scenic Cement .....	S191	9
Foam Pencil .....	ST1431	8	<b>PRODUCTS</b>		
2" Foam Nails.....	ST1432	5	Plaster Cloth.....	C1203	8
Hot Wire Foam Cutter .....	ST1435	3	Alternative Plaster Cloths.....	C1191-C1193	8
12 fl oz Foam Tack Glue .....	ST1444	3	Single Cut Stone Portal.....	C1253	18
Low Temp Foam Glue Gun .....	ST1445	3	Random Stone Culvert.....	C1264	19

## Complete Your Layout

To complete your layout, purchase the River Pass Scenery Kit #2 (S1488) and the Building Kits #3 (S1487). Save money over purchasing items separately.



River Pass Scenery Kit #2 - S1488



River Pass Building Kits #3 - S1487

# Track Plan

Fig. 65

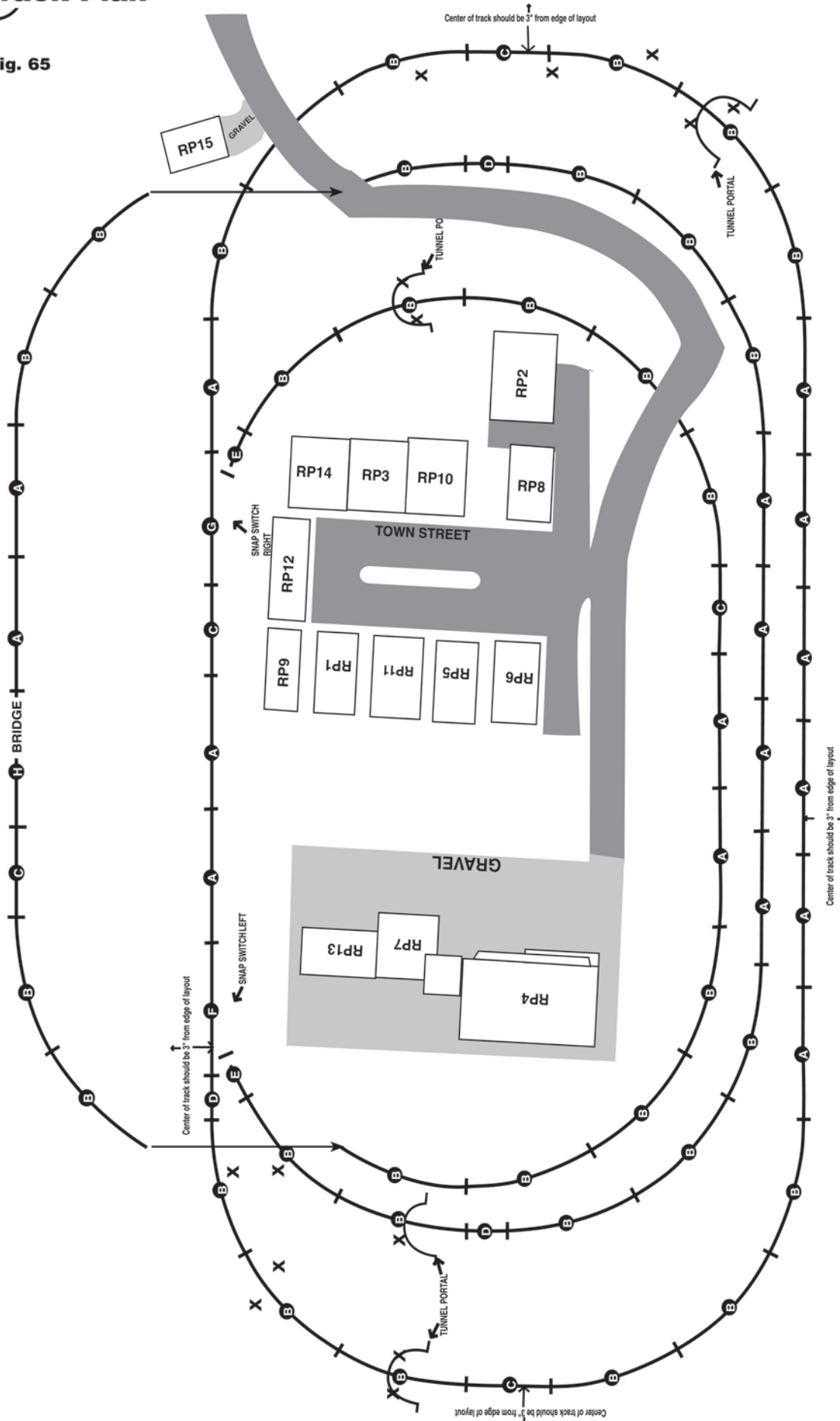

- |                                     |        |
|-------------------------------------|--------|
| A = 9" STRAIGHT.....                | 17 pcs |
| B = Full Section 18" Radius .....   | 34 pcs |
| C = 6" STRAIGHT .....               | 5 pcs  |
| D = 3" STRAIGHT .....               | 3 pcs  |
| E = 1/3 18" Radius .....            | 2 pcs  |
| F = Snap Switch left - remote ..... | 1 pc   |
| G = Snap Switch right - remote..... | 1 pc   |
| H = Warren Truss Bridge.....        | 1 pc   |
| X = Tunnel Wall Supports            |        |